



Gebr. Becker GmbH
Hölker Feld 29-31
D-42279 Wuppertal



Ersatzteilliste
Spare parts list
Liste de pièces de rechange
Listino pezzi di ricambio
Lista de piezas de recambio
Lista de peças sobresselentes
Reserveonderdelenlijst
Reservedelsliste
Reservdelslista

Reservedelsliste
Varaosaluettelo
Wykaz części zamiennych
Seznam náhradních dílů
Tartalékalkatrész lista
Κατάλογος ανταλλακτικών
Перечень запасных частей
备用零件目录
スペアパーツリスト

SV 5.690
SV 5.1050

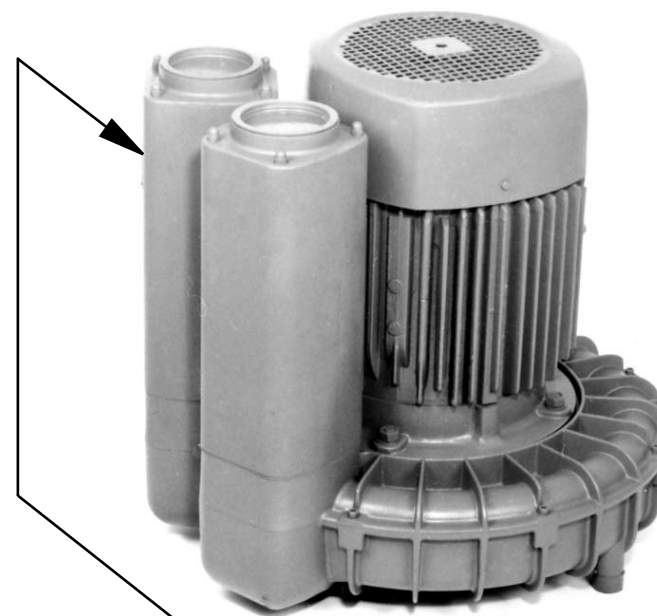

28011400000 11/2005

 SERVICE		Index Option	(D) Service: Tel: +49 (0)202 697-171 Fax: +49 (0)202 64 44 74 E-Mail: info@becker-international.com www.becker-international.com													
	<table border="1"> <tr><td colspan="2">Made in Germany</td></tr> <tr><td>BECKER</td><td>Baujahr/year XXXX</td></tr> <tr><td>D-42279 Wuppertal</td><td>No. B-XXXX</td></tr> <tr><td>Typ</td><td>SV 5.1050-XX</td></tr> <tr><td>Drehzahl / speed</td><td>XXXX min⁻¹</td></tr> <tr><td>Leistungsbedarf / motor power required</td><td>XXXX kW</td></tr> <tr><td>Saugvermögen / inlet capacity</td><td>XXXX m³/h</td></tr> <tr><td>Saugdruck / vacuum</td><td>XXXX mbar</td></tr> </table>			Made in Germany		BECKER	Baujahr/year XXXX	D-42279 Wuppertal	No. B-XXXX	Typ	SV 5.1050-XX	Drehzahl / speed	XXXX min ⁻¹	Leistungsbedarf / motor power required	XXXX kW	Saugvermögen / inlet capacity
Made in Germany																
BECKER	Baujahr/year XXXX															
D-42279 Wuppertal	No. B-XXXX															
Typ	SV 5.1050-XX															
Drehzahl / speed	XXXX min ⁻¹															
Leistungsbedarf / motor power required	XXXX kW															
Saugvermögen / inlet capacity	XXXX m ³ /h															
Saugdruck / vacuum	XXXX mbar															

Index	Pos.	Bestell Nr.	Beschreibung	
SV 5.690	4	906611 10000	WÄLZLAGER 3208 2 RS C3 TA	
	5	911317 00000	DICHTUNGSSCHLAUCH	
	6	000100 16800	GEHÄUSE (SV5.690/1)	
	6	000101 16800	GEHÄUSE (SV5.690/2)	
	7	013901 16900	DISTANZBUCHSE	
	8	946937 00000	STIFTSCHRAUBE	
	9	951705 00000	FEDERSCHEIBE	
	10	947107 00000	SECHSKANTMUTTER	
	11	511400 16600	SATZ DISTANZSCHEIBEN	
	12	000600 16900	LAUFRAD	
	13	016800 16900	SPANNSCHEIBE	
	14	945243 00000	SECHSKANTSCHRAUBE	
	15	948509 00000	FEDERRING	
	16	906578 00000	WELLENDICHTRING	
	18	000200 16800	GEHÄUSEDECKEL (SV5.690/1)	
	18	000203 16800	GEHÄUSEDECKEL (SV5.690/2)	
	19	945323 00000	INNENSECHSKANTSCHRAUBE	
	20	951703 00000	FEDERSCHEIBE	
21	007403 16900	SCHALLDÄMPFERGEHÄUSE		
22	007700 16900	DÄMPFER		
23	007600 16900	SIEBROHR		
25	003801 16900	ZUGANKERSCHRAUBE		
26	003803 16800	ZUGANKERSCHRAUBE		
30	007500 16900	DICHTUNG		
33	741310 10000	GUMMIPUFFER		
35	515103 16800	GERÄTEFUSS, KOMPL. / BG112 ¹⁾		
35	515100 16800	GERÄTEFUSS, KOMPL. / BG132 ¹⁾		
35	515101 16800	GERÄTEFUSS, KOMPL. / BG160 ¹⁾		
46	007800 16900	ANSCHLUSSFLANSCH		
105	507500 16900	DICHTUNG		
135	515102 16800	FUSS, (3x) ¹⁾		
181	015500 16800	REDUZIERSTÜCK (SV5.690/2)		
183	005601 16800	DECKEL (SV5.690/2)		
185	005600 16800	DECKEL (SV5.690/2)		
187	945374 00000	INNENSECHSKANTSCHRAUBE (SV5.690/2)		
M1 ²⁾	906639 00000	MOTORLAGER 6306		
M1 ²⁾	906635 00000	MOTORLAGER 6308		
M1 ²⁾	906616 40000	MOTORLAGER 6208		
M1 ²⁾	906615 50000	MOTORLAGER 6309		
M1 ²⁾	906615 70000	MOTORLAGER 6310		

¹⁾ optional

²⁾ motorabhängig

OPTIONAL

SV 5.690	/1-05	Sonderausführung - Korrosionsschutz
	/1-30	Sonderausführung - ohne Schalldämpfer
	/1-48	Sonderausführung
	/2-510	Sonderausführung

Abweichende Positionen zum Standardgerät - siehe Anhang (Zeichnungsrückseite) 

Index	Pos.	Bestell Nr.	Beschreibung	
SV 5.1050	4	906611 10000	WÄLZLAGER 3208 2 RS C3 TA	
	5	911317 00000	DICHTUNGSSCHLAUCH	
	6	000101 16900	GEHÄUSE	
	7	013901 16900	DISTANZBUCHSE	
	8	946937 00000	STIFTSCHRAUBE	
	9	951705 00000	FEDERSCHEIBE	
	10	947107 00000	SECHSKANTMUTTER	
	11	511400 16600	SATZ DISTANZSCHEIBEN	
	12	000600 16900	LAUFRAD	
	13	016800 16900	SPANNSCHEIBE	
	14	945243 00000	SECHSKANTSCHRAUBE	
	15	948509 00000	FEDERRING	
	16	906578 00000	WELLENDICHTRING	
	18	000200 16900	GEHÄUSEDECKEL	
	19	945363 00000	INNENSECHSKANTSCHRAUBE	
	20	951703 00000	FEDERSCHEIBE	
	21	007403 16900	SCHALLDÄMPFERGEHÄUSE	
	22	007700 16900	DÄMPFER	
23	007600 16900	SIEBROHR		
25	003801 16900	ZUGANKERSCHRAUBE		
26	003803 16800	ZUGANKERSCHRAUBE		
27	951703 00000	FEDERSCHEIBE		
30	007500 16900	DICHTUNG		
33	741310 10000	GUMMIPUFFER		
35	515100 16800	GERÄTEFUSS, KOMPL. / BG132 ¹⁾		
35	515101 16800	GERÄTEFUSS, KOMPL. / BG160 ¹⁾		
46	007800 16900	ANSCHLUSSFLANSCH		
105	507500 16900	DICHTUNG		
M1 ²⁾	906639 00000	MOTORLAGER 6306		
M1 ²⁾	906635 00000	MOTORLAGER 6308		
M1 ²⁾	906616 40000	MOTORLAGER 6208		
M1 ²⁾	906615 50000	MOTORLAGER 6309		
M1 ²⁾	906615 70000	MOTORLAGER 6310		

¹⁾ optional

²⁾ motorabhängig

OPTIONAL

SV 5.1050	/1-05	Sonderausführung - Korrosionsschutz
	/1-30	Sonderausführung - ohne Schalldämpfer
	/1-48	Sonderausführung

Abweichende Positionen zum Standardgerät - siehe Anhang (Zeichnungsrückseite) 

Index	Pos.	Ident No.	Description
SV 5.690	4	906611 10000	BALL BEARING 3208 2 RS C3 TA
	5	911317 00000	SEAL
	6	000100 16800	PUMP BODY (SV5.690/1)
	6	000101 16800	PUMP BODY (SV5.690/2)
	7	013901 16900	SPACER
	8	946937 00000	STUD
	9	951705 00000	SPRING DISC
	10	947107 00000	HEX. NUT
	11	511400 16600	SET DISTANCE DISC
	12	000600 16900	IMPELLER
	13	016800 16900	CLAMPING DISC
	14	945243 00000	HEX-HEAD SCREW
	15	948509 00000	SPRING WASHER
	16	906578 00000	SHAFT-SEALING RING
	18	000200 16800	HOUSING LID (SV5.690/1)
	18	000203 16800	HOUSING LID (SV5.690/2)
	19	945323 00000	SOCKET HEAD SCREW
	20	951703 00000	LOCKING WASHER
21	007403 16900	SILENCER HOUSING	
22	007700 16900	SILENCER SPONGE	
23	007600 16900	STRAINER TUBE	
25	003801 16900	ANCHORING SCREW	
26	003803 16800	ANCHORING SCREW	
30	007500 16900	GASKET	
33	741310 10000	RUBBER BUFFER	
35	515103 16800	FOOT, COMPL. / BG112 ¹⁾	
35	515100 16800	FOOT, COMPL. / BG132 ¹⁾	
35	515101 16800	FOOT, COMPL. / BG160 ¹⁾	
46	007800 16900	CONNECTING FLANGE	
105	507500 16900	GASKET	
135	515102 16800	FOOT, (3x) ¹⁾	
181	015500 16800	REDUCING PIECE (SV5.690/2)	
183	005601 16800	CAP (SV5.690/2)	
185	005600 16800	CAP (SV5.690/2)	
187	945374 00000	SOCKET HEAD SCREW (SV5.690/2)	
M1 ²⁾	906639 00000	BALL BEARING 6306	
M1 ²⁾	906635 00000	BALL BEARING 6308	
M1 ²⁾	906616 40000	BALL BEARING 6208	
M1 ²⁾	906615 50000	BALL BEARING 6309	
M1 ²⁾	906615 70000	BALL BEARING 6310	

¹⁾ optional
²⁾ motor-dependent

OPTIONAL	SV 5.690	/1-05	Special design - corrosion protection
		/1-30	Special design - without silencer
		/1-48	Special design
		/2-510	Special design

Items different from standard appliance see appendix (back of drawing) 

Index	Pos.	Ident No.	Description
SV 5.1050	4	906611 10000	BALL BEARING 3208 2 RS C3 TA
	5	911317 00000	SEAL
	6	000101 16900	PUMP BODY
	7	013901 16900	SPACER
	8	946937 00000	STUD
	9	951705 00000	SPRING DISC
	10	947107 00000	HEX. NUT
	11	511400 16600	SET DISTANCE DISC
	12	000600 16900	IMPELLER
	13	016800 16900	CLAMPING DISC
	14	945243 00000	HEX-HEAD SCREW
	15	948509 00000	SPRING WASHER
	16	906578 00000	SHAFT-SEALING RING
	18	000200 16900	HOUSING LID
	19	945363 00000	SOCKET HEAD SCREW
	20	951703 00000	LOCKING WASHER
	21	007403 16900	SILENCER HOUSING
	22	007700 16900	SILENCER SPONGE
23	007600 16900	STRAINER TUBE	
25	003801 16900	SCREW	
26	003803 16800	ANCHORING SCREW	
27	951703 00000	LOCKING WASHER	
30	007500 16900	GASKET	
33	741310 10000	RUBBER BUFFER	
35	515100 16800	FOOT, COMPL. / BG132 ¹⁾	
35	515101 16800	FOOT, COMPL. / BG160 ¹⁾	
46	007800 16900	CONNECTING FLANGE	
105	507500 16900	GASKET	
M1 ²⁾	906639 00000	BALL BEARING 6306	
M1 ²⁾	906635 00000	BALL BEARING 6308	
M1 ²⁾	906616 40000	BALL BEARING 6208	
M1 ²⁾	906615 50000	BALL BEARING 6309	
M1 ²⁾	906615 70000	BALL BEARING 6310	

¹⁾ optional
²⁾ motor-dependent

OPTIONAL	SV 5.1050	/1-05	Special design - corrosion protection
		/1-30	Special design - without silencer
		/1-48	Special design

Items different from standard appliance see appendix (back of drawing) 

Index	Pos.	No. Identification	Designation
SV 5.690	4	906611 10000	ROULEMENT A BILLES 3208 2 RS C3 TA
	5	911317 00000	JOINT
	6	000100 16800	CORP DE POMPE (SV5.690/1)
	6	000101 16800	CORP DE POMPE (SV5.690/2)
	7	013901 16900	DOUILLE
	8	946937 00000	PRISONNIER
	9	951705 00000	DISQUE DE RESSORT
	10	947107 00000	ECROU A 6 PANS
	11	511400 16600	JEU DISQUE DE TOLERANCE
	12	000600 16900	ROUE
	13	016800 16900	DISQUE DE SERRAGE
	14	945243 00000	VIS HEXAGONALE
	15	948509 00000	ANNEAU-RESSORT
	16	906578 00000	BAGUE D'ETANCHEITE P.L'AXE
	18	000200 16800	COUVERCLE (SV5.690/1)
	18	000203 16800	COUVERCLE (SV5.690/2)
	19	945323 00000	VIS HEXAGONALE INTERNE
	20	951703 00000	RONDELLE À RESSORT
21	007403 16900	CARCASSE SILENCIEUX	
22	007700 16900	MOUSSE POUR SILENCIEUX	
23	007600 16900	GRILLE POUR SILENCIEUX	
25	003801 16900	VIS D'ANCRAGE	
26	003803 16800	VIS D'ANCRAGE	
30	007500 16900	JOINT	
33	741310 10000	AMORTISSEUR EN CAOUTCHOUC	
35	515103 16800	PIED, COMPL. / BG112 ¹⁾	
35	515100 16800	PIED, COMPL. / BG132 ¹⁾	
35	515101 16800	PIED, COMPL. / BG160 ¹⁾	
46	007800 16900	BRIDE DE RACCORDEMENT	
105	507500 16900	JOINT	
135	515102 16800	PIED, (3x) ¹⁾	
181	015500 16800	PIECE DE REDUCTION (SV5.690/2)	
183	005601 16800	COUVERCLE (SV5.690/2)	
185	005600 16800	COUVERCLE (SV5.690/2)	
187	945374 00000	VIS HEXAGONALE INTERNE (SV5.690/2)	
M1 ²⁾	906639 00000	ROULEMENT A BILLES 6306	
M1 ²⁾	906635 00000	ROULEMENT A BILLES 6308	
M1 ²⁾	906616 40000	ROULEMENT A BILLES 6208	
M1 ²⁾	906615 50000	ROULEMENT A BILLES 6309	
M1 ²⁾	906615 70000	ROULEMENT A BILLES 6310	

¹⁾ en option

²⁾ dépendant du moteur

EN OPTION

SV 5.690 /1-05 Fabrication spéciale – protection contre la corrosion
 /1-30 Fabrication spéciale – sans silencieux
 /1-48 Fabrication spéciale
 /2-510 Fabrication spéciale

Articles divergents vis-à-vis de l'appareil standard, voir annexe (dos du dessin / du plan)

Index	Pos.	No. Identification	Designation
SV 5.1050	4	906611 10000	ROULEMENT A BILLES 3208 2 RS C3 TA
	5	911317 00000	JOINT
	6	000101 16900	CORP DE POMPE
	7	013901 16900	DOUILLE
	8	946937 00000	PRISONNIER
	9	951705 00000	DISQUE DE RESSORT
	10	947107 00000	ECROU A 6 PANS
	11	511400 16600	JEU DISQUE DE TOLERANCE
	12	000600 16900	ROUE
	13	016800 16900	DISQUE DE SERRAGE
	14	945243 00000	VIS HEXAGONALE
	15	948509 00000	ANNEAU-RESSORT
	16	906578 00000	BAGUE D'ETANCHEITE P.L'AXE
	18	000200 16900	COUVERCLE
	19	945363 00000	VIS HEXAGONALE INTERNE
	20	951703 00000	RONDELLE À RESSORT
	21	007403 16900	CARCASSE SILENCIEUX
	22	007700 16900	MOUSSE POUR SILENCIEUX
23	007600 16900	GRILLE POUR SILENCIEUX	
25	003801 16900	VIS	
26	003803 16800	VIS D'ANCRAGE	
27	951703 00000	RONDELLE À RESSORT	
30	007500 16900	JOINT	
33	741310 10000	AMORTISSEUR EN CAOUTCHOUC	
35	515100 16800	PIED, COMPL. / BG132 ¹⁾	
35	515101 16800	PIED, COMPL. / BG160 ¹⁾	
46	007800 16900	BRIDE DE RACCORDEMENT	
105	507500 16900	JOINT	
M1 ²⁾	906639 00000	ROULEMENT A BILLES 6306	
M1 ²⁾	906635 00000	ROULEMENT A BILLES 6308	
M1 ²⁾	906616 40000	ROULEMENT A BILLES 6208	
M1 ²⁾	906615 50000	ROULEMENT A BILLES 6309	
M1 ²⁾	906615 70000	ROULEMENT A BILLES 6310	

¹⁾ en option

²⁾ dépendant du moteur

EN OPTION

SV 5.1050 /1-05 Fabrication spéciale – protection contre la corrosion
 /1-30 Fabrication spéciale – sans silencieux
 /1-48 Fabrication spéciale

Articles divergents vis-à-vis de l'appareil standard, voir annexe (dos du dessin / du plan)

Index	Pos.	No. Identificazione	Designazione
			
SV 5.690	4	906611 10000	CUSCINETTO A SFERA 3208 2 RS C3 TA
	5	911317 00000	GUARNIZIONE
	6	000100 16800	CARCASSA (SV5.690/1)
	6	000101 16800	CARCASSA (SV5.690/2)
	7	013901 16900	BOCCOLA
	8	946937 00000	L'ASTA A VITE
	9	951705 00000	DISCO A MOLLA
	10	947107 00000	DADO ESAGONALE
	11	511400 16600	SERIE DISCO GIUOCO
	12	000600 16900	GIRANTE
	13	016800 16900	DISCO DI FISSAGGIO
	14	945243 00000	VITE ESAGONALE
	15	948509 00000	ANELLO A MOLLA
	16	906578 00000	GUARNIZIONE PER L'ALBERO
	18	000200 16800	COPERCHIO (SV5.690/1)
	18	000203 16800	COPERCHIO (SV5.690/2)
	19	945323 00000	VITE ESAGONALE INTERNA
	20	951703 00000	DISCO A MOLLA
	21	007403 16900	CARCASSA SILENZIATORE
	22	007700 16900	MATERIALE PER SILENZIATORE
23	007600 16900	TUBO-CRIVELLO	
25	003801 16900	CHIAVARDA D'ANCORAGGIO	
26	003803 16800	CHIAVARDA D'ANCORAGGIO	
30	007500 16900	GUARNIZIONE	
33	741310 10000	AMMORTIZZATORE IN GOMMA	
35	515103 16800	PIASTRA DI APPOGGIO, COMPL. / BG112 ¹⁾	
35	515100 16800	PIASTRA DI APPOGGIO, COMPL. / BG132 ¹⁾	
35	515101 16800	PIASTRA DI APPOGGIO, COMPL. / BG160 ¹⁾	
46	007800 16900	FLANGIA DI RACCORDO	
105	507500 16900	GUARNIZIONE	
135	515102 16800	PIASTRA, (3x) ¹⁾	
181	015500 16800	GIUNTO DI RIDUZIONE (SV5.690/2)	
183	005601 16800	COPERCHIO (SV5.690/2)	
185	005600 16800	COPERCHIO (SV5.690/2)	
187	945374 00000	VITE ESAGONALE INTERNA (SV5.690/2)	
M1 ²⁾	906639 00000	CUSCINETTO A SFERA 6306	
M1 ²⁾	906635 00000	CUSCINETTO A SFERA 6308	
M1 ²⁾	906616 40000	CUSCINETTO A SFERA 6208	
M1 ²⁾	906615 50000	CUSCINETTO A SFERA 6309	
M1 ²⁾	906615 70000	CUSCINETTO A SFERA 6310	

¹⁾ opzionale

²⁾ dipende del motore

OPTIONALE	SV 5.690	/1-05	Modello speciale - protezione anti-corrosione
		/1-30	Modello speciale - senza silenziatore
		/1-48	Modello speciale
		/2-510	Modello speciale

Vedere allegato (retro del disegno) per le posizioni divergenti dall'apparecchio standard 

Index	Pos.	No. Identificazione	Designazione
			
SV 5.1050	4	906611 10000	CUSCINETTO A SFERA 3208 2 RS C3 TA
	5	911317 00000	GUARNIZIONE
	6	000101 16900	CARCASSA
	7	013901 16900	BOCCOLA
	8	946937 00000	L'ASTA A VITE
	9	951705 00000	DISCO A MOLLA
	10	947107 00000	DADO ESAGONALE
	11	511400 16600	SERIE DISCO GIUOCO
	12	000600 16900	GIRANTE
	13	016800 16900	DISCO DI FISSAGGIO
	14	945243 00000	VITE ESAGONALE
	15	948509 00000	ANELLO A MOLLA
	16	906578 00000	GUARNIZIONE PER L'ALBERO
	18	000200 16900	COPERCHIO
	19	945363 00000	VITE ESAGONALE INTERNA
	20	951703 00000	DISCO A MOLLA
	21	007403 16900	CARCASSA SILENZIATORE
	22	007700 16900	MATERIALE PER SILENZIATORE
	23	007600 16900	TUBO-CRIVELLO
	25	003801 16900	VITE
26	003803 16800	CHIAVARDA D'ANCORAGGIO	
27	951703 00000	DISCO A MOLLA	
30	007500 16900	GUARNIZIONE	
33	741310 10000	AMMORTIZZATORE IN GOMMA	
35	515100 16800	PIASTRA DI APPOGGIO, COMPL. / BG132 ¹⁾	
35	515101 16800	PIASTRA DI APPOGGIO, COMPL. / BG160 ¹⁾	
46	007800 16900	FLANGIA DI RACCORDO	
105	507500 16900	GUARNIZIONE	
M1 ²⁾	906639 00000	CUSCINETTO A SFERA 6306	
M1 ²⁾	906635 00000	CUSCINETTO A SFERA 6308	
M1 ²⁾	906616 40000	CUSCINETTO A SFERA 6208	
M1 ²⁾	906615 50000	CUSCINETTO A SFERA 6309	
M1 ²⁾	906615 70000	CUSCINETTO A SFERA 6310	

¹⁾ opzionale

²⁾ dipende del motore

OPTIONALE	SV 5.1050	/1-05	Modello speciale - protezione anti-corrosione
		/1-30	Modello speciale - senza silenziatore
		/1-48	Modello speciale

Vedere allegato (retro del disegno) per le posizioni divergenti dall'apparecchio standard 

Index	Pos.	No. De pedido	Descripción	
SV 5.690	4	906611 10000	COJINETE DE RODAMIENTO 3208 2 RS C3 TA	
	5	911317 00000	MANGUERA DE JUNTA	
	6	000100 16800	CARCASA (SV5.690/1)	
	6	000101 16800	CARCASA (SV5.690/2)	
	7	013901 16900	CASQUILLO DISTANCIADOR	
	8	946937 00000	ESPÁRRAGO	
	9	951705 00000	ARANDELA ELÁSTICA	
	10	947107 00000	TUERCA HEXAGONAL	
	11	511400 16600	JUEGO DE ARANDELAS DISTANCIADORAS	
	12	000600 16900	RUEDA CORREDERA	
	13	016800 16900	ARANDELA TENSORA	
	14	945243 00000	TORNILLO DE CABEZA HEXAGONAL	
	15	948509 00000	ARANDELA DE MUELLE	
	16	906578 00000	ANILLO DE JUNTA DE ÁRBOL	
	18	000200 16800	TAPA DE CARCASA (SV5.690/1)	
	18	000203 16800	TAPA DE CARCASA (SV5.690/2)	
	19	945323 00000	TORNILLO HEXAGONAL INTERIOR	
	20	951703 00000	ARANDELA ELÁSTICA	
	21	007403 16900	CARCASA DE SILENCIADOR	
	22	007700 16900	AMORTIGUADOR	
	23	007600 16900	TUBO DE CRIBA	
25	003801 16900	TORNILLO DE ANCLAJE		
26	003803 16800	TORNILLO DE ANCLAJE		
30	007500 16900	JUNTA		
33	741310 10000	AMORTIGUADOR DE GOMA		
35	515103 16800	PIE DE APARATO, COMPL. / BG112 ¹⁾		
35	515100 16800	PIE DE APARATO, COMPL. / BG132 ¹⁾		
35	515101 16800	PIE DE APARATO, COMPL. / BG160 ¹⁾		
46	007800 16900	BRIDA DE EMPALME		
105	507500 16900	JUNTA		
135	515102 16800	PIE, (3x) ¹⁾		
181	015500 16800	PIEZA DE REDUCCIÓN (SV5.690/2)		
183	005601 16800	TAPA (SV5.690/2)		
185	005600 16800	TAPA (SV5.690/2)		
187	945374 00000	TORNILLO HEXAGONAL INTERIOR (SV5.690/2)		
M1 ²⁾	906639 00000	COJINETE DE RODAMIENTO 6306		
M1 ²⁾	906635 00000	COJINETE DE RODAMIENTO 6308		
M1 ²⁾	906616 40000	COJINETE DE RODAMIENTO 6208		
M1 ²⁾	906615 50000	COJINETE DE RODAMIENTO 6309		
M1 ²⁾	906615 70000	COJINETE DE RODAMIENTO 6310		

¹⁾ opcional

²⁾ dependiente del motor

OPTIONAL	SV 5.690	/1-05	Versión especial – protección contra la corrosión
		/1-30	Versión especial - sin silenciador
		/1-48	Versión especial
		/2-510	Versión especial

Para posiciones que derivan del aparato standard véase apéndice (lado trasero del plano) 

Index	Pos.	No. De pedido	Descripción	
SV 5.1050	4	906611 10000	COJINETE DE RODAMIENTO 3208 2 RS C3 TA	
	5	911317 00000	MANGUERA DE JUNTA	
	6	000101 16900	CARCASA	
	7	013901 16900	CASQUILLO DISTANCIADOR	
	8	946937 00000	ESPÁRRAGO	
	9	951705 00000	ARANDELA ELÁSTICA	
	10	947107 00000	TUERCA HEXAGONAL	
	11	511400 16600	JUEGO DE ARANDELAS DISTANCIADORAS	
	12	000600 16900	RUEDA CORREDERA	
	13	016800 16900	ARANDELA TENSORA	
	14	945243 00000	TORNILLO DE CABEZA HEXAGONAL	
	15	948509 00000	ARANDELA DE MUELLE	
	16	906578 00000	ANILLO DE JUNTA DE ÁRBOL	
	18	000200 16900	TAPA DE CARCASA	
	19	945363 00000	TORNILLO HEXAGONAL INTERIOR	
	20	951703 00000	ARANDELA ELÁSTICA	
	21	007403 16900	CARCASA DE SILENCIADOR	
	22	007700 16900	AMORTIGUADOR	
	23	007600 16900	TUBO DE CRIBA	
	25	003801 16900	TORNILLO TIRANTE	
	26	003803 16800	TORNILLO DE ANCLAJE	
27	951703 00000	ARANDELA ELÁSTICA		
30	007500 16900	JUNTA		
33	741310 10000	AMORTIGUADOR DE GOMA		
35	515100 16800	PIE DE APARATO, COMPL. / BG132 ¹⁾		
35	515101 16800	PIE DE APARATO, COMPL. / BG160 ¹⁾		
46	007800 16900	BRIDA DE EMPALME		
105	507500 16900	JUNTA		
M1 ²⁾	906639 00000	COJINETE DE RODAMIENTO 6306		
M1 ²⁾	906635 00000	COJINETE DE RODAMIENTO 6308		
M1 ²⁾	906616 40000	COJINETE DE RODAMIENTO 6208		
M1 ²⁾	906615 50000	COJINETE DE RODAMIENTO 6309		
M1 ²⁾	906615 70000	COJINETE DE RODAMIENTO 6310		

¹⁾ opcional

²⁾ dependiente del motor

OPTIONAL	SV 5.1050	/1-05	Versión especial – protección contra la corrosión
		/1-30	Versión especial - sin silenciador
		/1-48	Versión especial

Para posiciones que derivan del aparato standard véase apéndice (lado trasero del plano) 

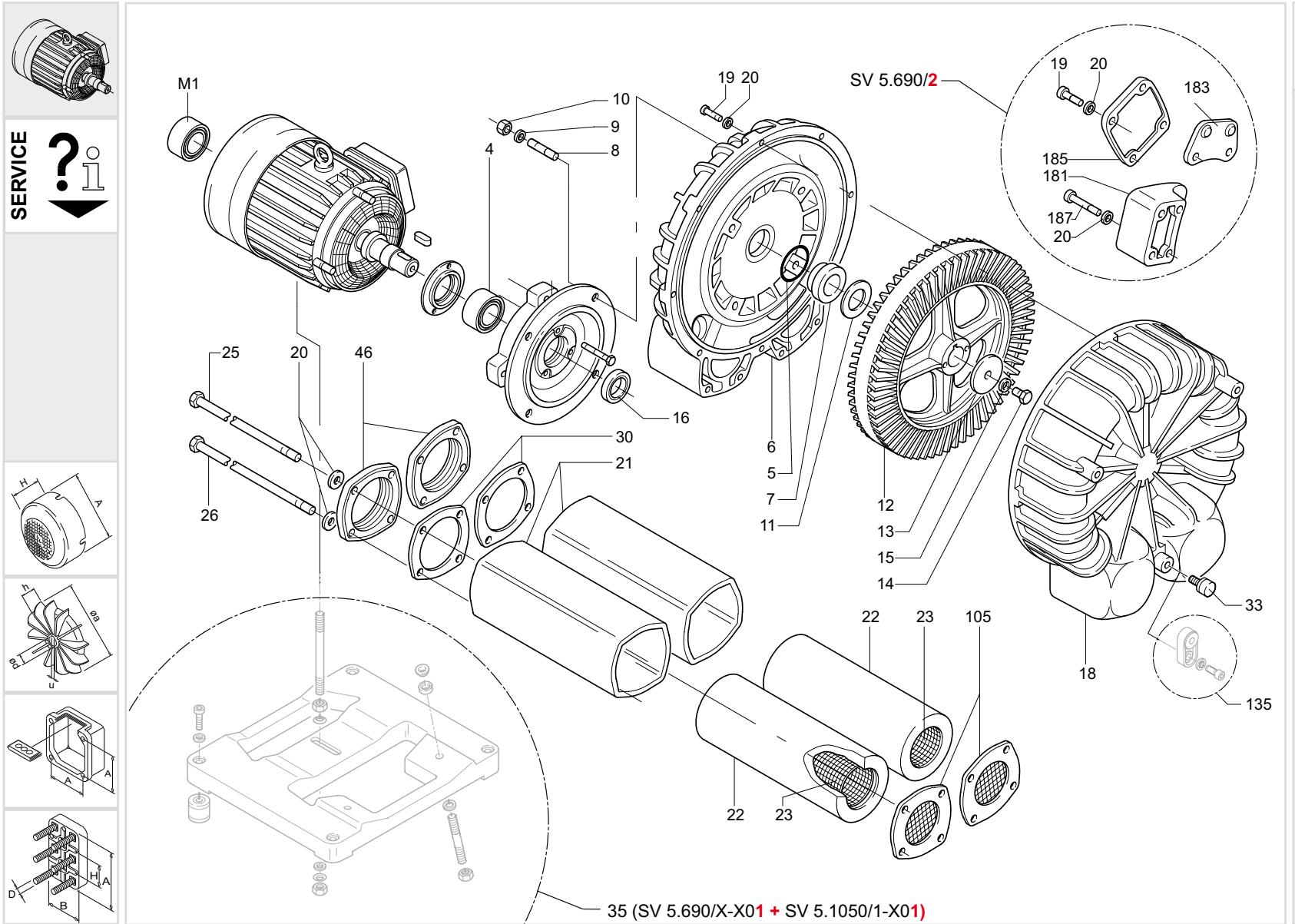



35 (SV 5.690/X-X01 + SV 5.1050/1-X01)

standard

SV 5.690/1
SV 5.690/2-50X
SV 5.1050/1

optional
en option
opcionale
opcional

optional en option optionale opcional 	Variante(n) Modifications Variantes	Pos ²⁾	Bestell Nr. / Ident No. / No. Identification / No. Identificazione / No. De pedido		Beschreibung / Description / Designation / Designazione / Descripcion
					
SV 5.690/X-XX SV 5.1050/1-XX	SV 5.690/1-05 SV 5.1050/1-05	6 6 12 13 18 18 21 23	000110 16800 000111 16900 000610 16900 016810 16900 000210 16800 000210 16900 007413 16900 007610 16900	000100 16800 000100 16900 000600 16900 016800 16900 000200 16800 000200 16900 007403 16900 007600 16900	SV 5.690 - GEHÄUSE / PUMP BODY / CORP DE POMPE / CARCASSA / CARCASA SV 5.1050 - GEHÄUSE / PUMP BODY / CORP DE POMPE / CARCASSA / CARCASA LAUFRAD / IMPELLER / ROUE / GIRANTE / RUEDA CORREDERA SPANNSCHEIBE / CLAMPING DISC / DISQUE DE SERRAGE / DISCO DI FISSAGGIO / ARANDELA TENSORA SV 5.690 - GEHÄUSEDECKEL / HOUSING LID / COUVERCLE / COPERCHIO / TAPA DE CARCASA SV 5.1050 - GEHÄUSEDECKEL / HOUSING LID / COUVERCLE / COPERCHIO / TAPA DE CARCASA SCHALLDÄMPFERGEHÄUSE / SILENCER HOUSING / CARCASSE SILENCIEUX / CARCASSA SILENZIATORE / CARCASA DE SILENCIADOR SIEBROHR / STRAINER TUBE / GRILLE POUR SILENCIEUX / TUBO-CRIVELLO / TUBO DE CRIBA
	SV 5.690/1-30 SV 5.1050/1-30	12 21 22 23 25 26 27 30 33 46 50 54	000602 16900 062900 16900 945320 00000	000600 16900 007403 16900 007700 16900 007600 16900 003801 16900 003803 16900 954703 00000 007500 16900 741310 10000 007800 16900	LAUFRAD / IMPELLER / ROUE / GIRANTE / RUEDA CORREDERA SCHALLDÄMPFERGEHÄUSE / SILENCER HOUSING / CARCASSE SILENCIEUX / CARCASSA SILENZIATORE / CARCASA DE SILENCIADOR DÄMPFER / SILENCER SPONGE / MOUSSE POUR SILENCIEUX / MATERIALE PER SILENZIATORE / AMORTIGUADOR SIEBROHR / STRAINER TUBE / GRILLE POUR SILENCIEUX / TUBO-CRIVELLO / TUBO DE CRIBA ZUGANKERSCHRAUBE / ANCHORING SCREW / VIS D'ANCRAGE / CHIAVARDA D'ANCORAGGIO / TORNILLO DE ANCLAJE ZUGANKERSCHRAUBE / ANCHORING SCREW / VIS D'ANCRAGE / CHIAVARDA D'ANCORAGGIO / TORNILLO DE ANCLAJE FEDERSCHEIBE / LOCKING WASHER / RONDELLE À RESSORT / DISCO A MOLLA / ARANDELA ELÁSTICA DICHTUNG / GASKET / JOINT / GUARNIZIONE / JUNTA GUMMIPUFFER / RUBBER BUFFER / AMORTISSEUR EN CAOUTCHOUC / AMMORTIZZATORE IN GOMMA / AMORTIGUADOR DE GOMA ANSCHLUSSFLANSCH / CONNECTING FLANGE / BRIDE DE RACCORDEMENT / FLANGIA DI RACCORDO / BRIDA DE EMPALME ABDECKUNG / COVERING / REVÊTEMENT / RIVESTIMENTO / RECUBRIMIENTO INNENSECHSKANTSCHRAUBE / SOCKET HEAD SCREW / VIS HEXAGONALE INTERNE / VITE ESAGONALE INTERNA / TORNILLO HEXAGONAL INTERIOR
	SV 5.690/1-48 SV 5.1050/1-48	12	000601 16900	000600 16900	LAUFRAD / IMPELLER / ROUE / GIRANTE / RUEDA CORREDERA
	SV 5.690/2-510	21 22 23	007405 16900 907702 00000 907600 30000 007602 57000	007403 16900 007700 16900 007600 16900	1x SCHALLDÄMPFERGEHÄUSE / 1x SILENCER HOUSING / 1x CARCASSE SILENCIEUX / 1x CARCASSA SILENZIATORE / 1x CARCASA DE SILENCIADOR DÄMPFER / SILENCER SPONGE / MOUSSE POUR SILENCIEUX / MATERIALE PER SILENZIATORE / AMORTIGUADOR SIEBROHR / STRAINER TUBE / GRILLE POUR SILENCIEUX / TUBO-CRIVELLO / TUBO DE CRIBA

²⁾ variantenabhängige Bauteile / variant-dependent components / composants variante-dependantes / componenti variante-dispendenti / componentes variante-dependientes