

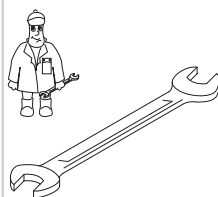

Gebr. Becker GmbH & Co.KG
Hölker Feld 29-31
D-42279 Wuppertal

Wartung
Maintenance
Entretien
Manutenzione
Mantenimiento



	Pos.	Menge ¹⁾ Quantity Quantité Quantità Cantidad	Bestell-Nr. Ident No. No. Identification No. Identificazione No. de pedido	Bezeichnung Description Designation Designazione Descripción
DT 4.10	24	7	901327 00000	Schieber, Rotor Vane, Palette, Silenciador
	72	1	909518 00000	Filterpatrone, Filter cartridge, Cartouche Filtrante, Cartuccia filtro, Cartucho de filtro
	74	1	909554 00000	Filterpatrone, Filter cartridge, Cartouche Filtrante, Cartuccia filtro, Cartucho de filtro
DT 4.16	24	7	901347 00000	Schieber, Rotor Vane, Palette, Silenciador
	72	1	909519 00000	Filterpatrone, Filter cartridge, Cartouche Filtrante, Cartuccia filtro, Cartucho de filtro
	74	1	909542 00000	Filterpatrone, Filter cartridge, Cartouche Filtrante, Cartuccia filtro, Cartucho de filtro

¹⁾ erforderliche Bestellmenge / necessary order quantity / quantité nécessaire / quantità di ordinazione necessari / cantidad necesario



Ersatzteilliste
Spare parts list
Liste de pièces de rechange
Listino pezzi di ricambio
Lista de piezas de recambio
Lista de peças sobresselentes
Reserveonderdelenlijst
Reservedelsliste
Reservdelslista

Reservedelsliste
Varaosaluettelo
Wykaz części zamiennych
Seznam náhradních dílů
Tartalékalkatrész lista
Κατάλογος ανταλλακτικών
Перечень запасных частей
备用零件目录
スペアパーツリスト

DT 4.10
DT 4.16



28008800000 08/2005

SERVICE

Made in Germany

BECKER Baujahr/year XXXX

No. DT 4.16-XX

Typ DT 4.16-XX

Drehzahl / speed XXXX min⁻¹

Leistungsbedarf motor power required XXXX kW

Saugvermögen inlet capacity XXXX m³/h

Saugdruck / vacuum XXXX mbar

Index
Option

Service:

Tel: +49 (0)202 697-171

Fax: +49 (0)202 64 44 74

E-Mail: info@becker-international.com

www.becker-international.com

Index	Pos.	Bestell Nr.	Beschreibung 
DT 4.10	15	020000 16200	KOLBEN
	16	016800 05000	SPANNSCHEIBE
	17	911001 00000	STAR-TOLERANZRING
	18	949203 00000	ZAHNSCHEIBE
	19	945320 00000	INNENSECHSKANTSCHRAUBE
	21	000100 16200	GEHÄUSE
	23	945319 00000	INNENSECHSKANTSCHRAUBE
	24	901327 00000	SCHIEBER-KOHL (7x) ¹⁾
	28	000700 16200	SEITENDECKEL
	29	945364 00000	INNENSECHSKANTSCHRAUBE
	30	008901 16200	DICHTUNG
	61	004800 27300	FILTERDECKEL
	67	009000 16300	ANPRESSFEDER
69	952009 00000	SPANNHÜLSE	
72	909518 00000	FILTERPATRONE (1x) ¹⁾	
74	909554 00000	FILTERPATRONE (1x) ¹⁾	
76	945364 00000	INNENSECHSKANTSCHRAUBE	
77	948021 00000	DICHTRING	
78	913161 00000	O-RING	
83	006800 27300	GERÄTEHAUBE	
84	060901 16300	DÄMPFUNGSSTREIFEN	
85	741310 50000	GUMMIPUFFER	
86	949402 00000	UNTERLEGSCHLEIBE	
87	947001 00000	SECHSKANTMUTTER	
88	006801 27300	FRONTHAUBE	
89	741310 40000	GUMMIPUFFER	
90	945318 00000	INNENSECHSKANTSCHRAUBE	
91	951922 00000	GUMMIFORMTEIL	
94	015100 27300	MOTORFUSS	
95	951921 00000	GUMMIFORMTEIL	
96	068000 27600	DISTANZSTÜCK	
97	945363 00000	INNENSECHSKANTSCHRAUBE	
98	949451 00000	UNTERLEGSCHLEIBE	
102	968104 00000	GUMMI-DISTANZSTÜCK	
103	029600 16300	BOLZEN	
123	728003 99611	DRUCKREGULIERVENTIL	
129	943131 00000	DÜSE	
133	951224 00000	VERSCHLUSS-SCHRAUBE	

¹⁾ erforderliche Bestellmenge / Wartung

DT 4.10 (1~) Ausführung - Einphasenwechselstrom

OPTIONAL

Abweichende Positionen zum Standardgerät - siehe Anhang (Zeichnungsrückseite) 

Index	Pos.	Bestell Nr.	Beschreibung 
DT 4.16	15	020000 16300	KOLBEN
	16	016800 16300	SPANNSCHEIBE
	17	911009 00000	STAR-TOLERANZRING
	18	949203 00000	ZAHNSCHEIBE
	19	945320 00000	INNENSECHSKANTSCHRAUBE
	21	000105 16300	GEHÄUSE
	23	945321 00000	INNENSECHSKANTSCHRAUBE
	24	901347 00000	SCHIEBER-KOHL (7x) ¹⁾
	28	000705 16300	SEITENDECKEL
	29	945372 00000	INNENSECHSKANTSCHRAUBE
	30	008901 16300	DICHTUNG
	61	004800 27400	FILTERDECKEL
	67	009000 16300	ANPRESSFEDER
69	952009 00000	SPANNHÜLSE	
72	909519 00000	FILTERPATRONE (1x) ¹⁾	
74	909542 00000	FILTERPATRONE (1x) ¹⁾	
76	945325 00000	INNENSECHSKANTSCHRAUBE	
77	948021 00000	DICHTRING	
78	913161 00000	O-RING	
83	006800 27400	GERÄTEHAUBE	
84	060901 16300	DÄMPFUNGSSTREIFEN	
85	741310 50000	GUMMIPUFFER	
86	949402 00000	UNTERLEGSCHLEIBE	
87	947001 00000	SECHSKANTMUTTER	
88	006801 27400	FRONTHAUBE	
89	741310 40000	GUMMIPUFFER	
90	945318 00000	INNENSECHSKANTSCHRAUBE	
91	951922 00000	GUMMIFORMTEIL	
94	015100 27400	MOTORFUSS	
95	951921 00000	GUMMIFORMTEIL	
96	068000 27600	DISTANZSTÜCK	
97	945363 00000	INNENSECHSKANTSCHRAUBE	
98	949451 00000	UNTERLEGSCHLEIBE	
102	968104 00000	GUMMI-DISTANZSTÜCK	
103	029600 16300	BOLZEN	
123	728003 99611	DRUCKREGULIERVENTIL	
129	943131 00000	DÜSE	
133	951224 00000	VERSCHLUSS-SCHRAUBE	

¹⁾ erforderliche Bestellmenge / Wartung

DT 4.16 (1~) Ausführung - Einphasenwechselstrom

DT 4.16/05-51 (1~) Sonderausführung

(3~) Sonderausführung

DT 4.16K/0-06 (3~) Ausführung mit Kühler - ohne Filterung / Drehstrom

OPTIONAL

Abweichende Positionen zum Standardgerät - siehe Anhang (Zeichnungsrückseite) 

Index	Pos.	Ident No.	Description 
DT 4.10	15	020000 16200	ROTOR
	16	016800 05000	CLAMPING DISC
	17	911001 00000	STAR-TOLERANCE-RING
	18	949203 00000	TOOTHED SPRING WASHER
	19	945320 00000	SOCKET HEAD SCREW
	21	000100 16200	PUMP BODY
	23	945319 00000	SOCKET HEAD SCREW
	24	901327 00000	CARBON VANES (7x)¹⁾
	28	000700 16200	LID
	29	945364 00000	SOCKET HEAD SCREW
	30	008901 16200	GASKET
	61	004800 27300	FILTER COVER
	67	009000 16300	BLADE SPRING
69	952009 00000	LOCATING PIN	
72	909518 00000	FILTER CARTRIDGE (1x)¹⁾	
74	909554 00000	FILTER CARTRIDGE (1x)¹⁾	
76	945364 00000	SOCKET HEAD SCREW	
77	948021 00000	SEALING RING	
78	913161 00000	O-RING	
83	006800 27300	PROTECTING HOOD	
84	060901 16300	ELASTIC PAD	
85	741310 50000	RUBBER BUFFER	
86	949402 00000	WASHER	
87	947001 00000	HEX.NUT	
88	006801 27300	PROTECTING HOOD (FRONT)	
89	741310 40000	RUBBER BUFFER	
90	945318 00000	SOCKET HEAD SCREW	
91	951922 00000	RUBBER ELEMENT	
94	015100 27300	FOOT	
95	951921 00000	RUBBER ELEMENT	
96	068000 27600	SPACING COLLAR	
97	945363 00000	SOCKET HEAD SCREW	
98	949451 00000	WASHER	
102	968104 00000	RUBBER SLEEVE	
103	029600 16300	BOLT	
123	728003 99611	PRESSURE REGULATING VALVE	
129	943131 00000	NOZZLE	
133	951224 00000	SCREW PLUG	

¹⁾ necessary order quantity / maintenance

DT 4.10 (1~) Design - single-phase AC

Items different from standard appliance see appendix (back of drawing) 

Index	Pos.	Ident No.	Description 
DT 4.16	15	020000 16300	ROTOR
	16	016800 16300	CLAMPING DISC
	17	911009 00000	STAR-TOLERANCE-RING
	18	949203 00000	TOOTHED SPRING WASHER
	19	945320 00000	SOCKET HEAD SCREW
	21	000105 16300	PUMP BODY
	23	945321 00000	SOCKET HEAD SCREW
	24	901347 00000	CARBON VANES (7x)¹⁾
	28	000705 16300	LID
	29	945372 00000	SOCKET HEAD SCREW
	30	008901 16300	GASKET
	61	004800 27400	FILTER COVER
	67	009000 16300	BLADE SPRING
69	952009 00000	LOCATING PIN	
72	909519 00000	FILTER CARTRIDGE (1x)¹⁾	
74	909542 00000	FILTER CARTRIDGE (1x)¹⁾	
76	945325 00000	SOCKET HEAD SCREW	
77	948021 00000	SEALING RING	
78	913161 00000	O-RING	
83	006800 27400	PROTECTING HOOD	
84	060901 16300	ELASTIC PAD	
85	741310 50000	RUBBER BUFFER	
86	949402 00000	WASHER	
87	947001 00000	HEX.NUT	
88	006801 27400	PROTECTING HOOD (FRONT)	
89	741310 40000	RUBBER BUFFER	
90	945318 00000	SOCKET HEAD SCREW	
91	951922 00000	RUBBER ELEMENT	
94	015100 27400	FOOT	
95	951921 00000	RUBBER ELEMENT	
96	068000 27600	SPACING COLLAR	
97	945363 00000	SOCKET HEAD SCREW	
98	949451 00000	WASHER	
102	968104 00000	RUBBER SLEEVE	
103	029600 16300	BOLT	
123	728003 99611	PRESSURE REGULATING VALVE	
129	943131 00000	NOZZLE	
133	951224 00000	SCREW PLUG	

¹⁾ necessary order quantity / maintenance

DT 4.16 (1~) Design - single-phase AC
DT 4.16/05-51 (1~) Special design
(3~) Special design
DT 4.16K/0-06 (3~) Design with cooler - without filter / three phase AC

Items different from standard appliance see appendix (back of drawing) 

Index	Pos.	No. Identification	Designation
DT 4.10	15	020000 16200	PISTON
	16	016800 05000	DISQUE DE SERRAGE
	17	911001 00000	BAGUE STAR
	18	949203 00000	DENT DISQUE
	19	945320 00000	VIS HEXAGONALE INTERNE
	21	000100 16200	CORP DE POMPE
	23	945319 00000	VIS HEXAGONALE INTERNE
	24	901327 00000	PALETTE DE CHARBON (7x)¹⁾
	28	000700 16200	COUVERCLE
	29	945364 00000	VIS HEXAGONALE INTERNE
	30	008901 16200	JOINT
	61	004800 27300	COUVERCLE DU FILTRE
	67	009000 16300	RESSORT-JAME
69	952009 00000	DOVILLE DE ETRAGE	
72	909518 00000	CARTOUCHE FILTRANTE (1x)¹⁾	
74	909554 00000	CARTOUCHE FILTRANTE (1x)¹⁾	
76	945364 00000	VIS HEXAGONALE INTERNE	
77	948021 00000	JOINT	
78	913161 00000	ANNEAU-O	
83	006800 27300	CARTER PROTECTEUR	
84	060901 16300	AMORTISSEUR	
85	741310 50000	AMORTISSEUR EN CAOUTCHOUC	
86	949402 00000	RONDELLE	
87	947001 00000	ECROU A 6PANS	
88	006801 27300	CARTER PROTECTEUR	
89	741310 40000	AMORTISSEUR EN CAOUTCHOUC	
90	945318 00000	VIS HEXAGONALE INTERNE	
91	951922 00000	ELEMENT EN CAOUTCHOUC	
94	015100 27300	PIED	
95	951921 00000	ELEMENT EN CAOUTCHOUC	
96	068000 27600	DONILLE D'ECARMENT	
97	945363 00000	VIS HEXAGONALE INTERNE	
98	949451 00000	RONDELLE	
102	968104 00000	PIECE D'ECARTEMENT CAOUTCHOUC	
103	029600 16300	BOULON	
123	728003 99611	SOUPAPE REGLAGE PRESSION	
129	943131 00000	AJUTAGE	
133	951224 00000	BOUCHON	

¹⁾ quantité nécessaire / entretien

DT 4.10 (1~) Fabrication - AC monophasé

Articles divergents vis-à-vis de l'appareil standard, voir annexe (dos du dessin / du plan)

EN OPTION

Index	Pos.	No. Identification	Designation
DT 4.16	15	020000 16300	PISTON
	16	016800 16300	DISQUE DE SERRAGE
	17	911009 00000	BAGUE STAR
	18	949203 00000	DENT DISQUE
	19	945320 00000	VIS HEXAGONALE INTERNE
	21	000105 16300	CORP DE POMPE
	23	945321 00000	VIS HEXAGONALE INTERNE
	24	901347 00000	PALETTE DE CHARBON (7x)¹⁾
	28	000705 16300	COUVERCLE
	29	945372 00000	VIS HEXAGONALE INTERNE
	30	008901 16300	JOINT
	61	004800 27400	COUVERCLE DU FILTRE
	67	009000 16300	RESSORT-JAME
69	952009 00000	DOVILLE DE ETRAGE	
72	909519 00000	CARTOUCHE FILTRANTE (1x)¹⁾	
74	909542 00000	CARTOUCHE FILTRANTE (1x)¹⁾	
76	945325 00000	VIS HEXAGONALE INTERNE	
77	948021 00000	JOINT	
78	913161 00000	ANNEAU-O	
83	006800 27400	CARTER PROTECTEUR	
84	060901 16300	AMORTISSEUR	
85	741310 50000	AMORTISSEUR EN CAOUTCHOUC	
86	949402 00000	RONDELLE	
87	947001 00000	ECROU A 6PANS	
88	006801 27400	CARTER PROTECTEUR	
89	741310 40000	AMORTISSEUR EN CAOUTCHOUC	
90	945318 00000	VIS HEXAGONALE INTERNE	
91	951922 00000	ELEMENT EN CAOUTCHOUC	
94	015100 27400	PIED	
95	951921 00000	ELEMENT EN CAOUTCHOUC	
96	068000 27600	DONILLE D'ECARMENT	
97	945363 00000	VIS HEXAGONALE INTERNE	
98	949451 00000	RONDELLE	
102	968104 00000	PIECE D'ECARTEMENT CAOUTCHOUC	
103	029600 16300	BOULON	
123	728003 99611	SOUPAPE REGLAGE PRESSION	
129	943131 00000	AJUTAGE	
133	951224 00000	BOUCHON	

¹⁾ quantité nécessaire / entretien

DT 4.16 (1~) Fabrication - AC monophasé
DT 4.16/05-51 (1~) Fabrication spéciale
(3~) Fabrication spéciale
DT 4.16K/0-06 (3~) Fabrication avec refroidisseur - sans filtre / AC triphasé

Articles divergents vis-à-vis de l'appareil standard, voir annexe (dos du dessin / du plan)

EN OPTION

Index	Pos.	No. Identificazione	Designazione
DT 4.10	15	020000 16200	ROTORE
	16	016800 05000	DISCO DI FISSAGGIO
	17	911001 00000	STAR-ANELLO TOLLERANZA
	18	949203 00000	DISCO A DENTE
	19	945320 00000	VITE ESAGONALE INTERNA
	21	000100 16200	CARCASSA
	23	945319 00000	VITE ESAGONALE INTERNA
	24	901327 00000	PALETTE DI CHARBONE (7x)¹⁾
	28	000700 16200	COPERCHIO
	29	945364 00000	VITE ESAGONALE INTERNA
	30	008901 16200	GUARNIZIONE
	61	004800 27300	COPERCHIO FILTRO
	67	009000 16300	MOLLA
69	952009 00000	SPINE DI RISCONTRO	
72	909518 00000	CARTUCCIA FILTRO (1x)¹⁾	
74	909554 00000	CARTUCCIA FILTRO (1x)¹⁾	
76	945364 00000	VITE ESAGONALE INTERNA	
77	948021 00000	ANELLO GUARNIZIONE	
78	913161 00000	ANELLO-O	
83	006800 27300	CAPOTO DI PROTEZIONE	
84	060901 16300	AMORTIZZATORE	
85	741310 50000	AMMORTIZZATORE IN GOMMA	
86	949402 00000	RONDELLA	
87	947001 00000	DADO ESAGONALE	
88	006801 27300	CARTER DI PROTEZIONE	
89	741310 40000	AMMORTIZZATORE IN GOMMA	
90	945318 00000	VITE ESAGONALE INTERNA	
91	951922 00000	ELEMENTO IN GOMMA	
94	015100 27300	PIEDE	
95	951921 00000	ELEMENTO IN GOMMA	
96	068000 27600	BOCCOLA DISTANZIATRICE	
97	945363 00000	VITE ESAGONALE INTERNA	
98	949451 00000	RONDELLA	
102	968104 00000	PEZZO DI SCOSTAM. IN GOMMA	
103	029600 16300	BULLONE	
123	728003 99611	VALVOLA REGOLAZIONE PRESSIONE	
129	943131 00000	UGELLO	
133	951224 00000	VITE DI CHIUSURA	

¹⁾ quantità di ordinazione necessari / manutenzione

DT 4.10 (1~) Modello - AC monofase

Vedere allegato (retro del disegno) per le posizioni divergenti dall'apparecchio standard

Index	Pos.	No. Identificazione	Designazione
DT 4.16	15	020000 16300	ROTORE
	16	016800 16300	DISCO DI FISSAGGIO
	17	911009 00000	STAR-ANELLO TOLLERANZA
	18	949203 00000	DISCO A DENTE
	19	945320 00000	VITE ESAGONALE INTERNA
	21	000105 16300	CARCASSA
	23	945321 00000	VITE ESAGONALE INTERNA
	24	901347 00000	PALETTE DI CHARBONE (7x)¹⁾
	28	000705 16300	COPERCHIO
	29	945372 00000	VITE ESAGONALE INTERNA
	30	008901 16300	GUARNIZIONE
	61	004800 27400	COPERCHIO FILTRO
	67	009000 16300	MOLLA
69	952009 00000	SPINE DI RISCONTRO	
72	909519 00000	CARTUCCIA FILTRO (1x)¹⁾	
74	909542 00000	CARTUCCIA FILTRO (1x)¹⁾	
76	945325 00000	VITE ESAGONALE INTERNA	
77	948021 00000	ANELLO GUARNIZIONE	
78	913161 00000	ANELLO-O	
83	006800 27400	CAPOTO DI PROTEZIONE	
84	060901 16300	AMORTIZZATORE	
85	741310 50000	AMMORTIZZATORE IN GOMMA	
86	949402 00000	RONDELLA	
87	947001 00000	DADO ESAGONALE	
88	006801 27400	CARTER DI PROTEZIONE	
89	741310 40000	AMMORTIZZATORE IN GOMMA	
90	945318 00000	VITE ESAGONALE INTERNA	
91	951922 00000	ELEMENTO IN GOMMA	
94	015100 27400	PIEDE	
95	951921 00000	ELEMENTO IN GOMMA	
96	068000 27600	BOCCOLA DISTANZIATRICE	
97	945363 00000	VITE ESAGONALE INTERNA	
98	949451 00000	RONDELLA	
102	968104 00000	PEZZO DI SCOSTAM. IN GOMMA	
103	029600 16300	BULLONE	
123	728003 99611	VALVOLA REGOLAZIONE PRESSIONE	
129	943131 00000	UGELLO	
133	951224 00000	VITE DI CHIUSURA	

¹⁾ quantità di ordinazione necessari / manutenzione

DT 4.16 (1~) Modello - AC monofase
DT 4.16/05-51 (1~) Modello speciale
(3~) Modello speciale
DT 4.16K/0-06 (3~) Modello con raffreddatore - senza filtro / AC trifase

Vedere allegato (retro del disegno) per le posizioni divergenti dall'apparecchio standard

OPZIONALE

OPZIONALE

Index	Pos.	No. De pedido	Descripción 
DT 4.10	15	020000 16200	ÉMBOLO
	16	016800 05000	ARANDELA TENSORA
	17	911001 00000	ANILLO DE TOLERANCIA STAR
	18	949203 00000	POLEA DENTADA
	19	945320 00000	TORNILLO HEXAGONAL INTERIOR
	21	000100 16200	CARCASA
	23	945319 00000	TORNILLO HEXAGONAL INTERIOR
	24	901327 00000	EMPUJADOR DE CARBÓN (7x)¹⁾
	28	000700 16200	TAPA LATERAL
	29	945364 00000	TORNILLO HEXAGONAL INTERIOR
	30	008901 16200	JUNTA
	61	004800 27300	TAPA DE FILTRO
	67	009000 16300	MUELLE DE PRESIÓN
69	952009 00000	CASQUILLO TENSOR	
72	909518 00000	CARTUCHO DE FILTRO (1x)¹⁾	
74	909554 00000	CARTUCHO DE FILTRO (1x)¹⁾	
76	945364 00000	TORNILLO HEXAGONAL INTERIOR	
77	948021 00000	ANILLO DE JUNTA	
78	913161 00000	JUNTA TÓRICA	
83	006800 27300	CAPERUZA DE APARATO	
84	060901 16300	TIRAS DE AMORTIGUACIÓN	
85	741310 50000	AMORTIGUADOR DE GOMA	
86	949402 00000	ARANDELA	
87	947001 00000	TUERCA HEXAGONAL	
88	006801 27300	CAPERUZA FRONTAL	
89	741310 40000	AMORTIGUADOR DE GOMA	
90	945318 00000	TORNILLO HEXAGONAL INTERIOR	
91	951922 00000	PIEZA DE ORMA DE GOMA	
94	015100 27300	PIE DE MOTOR	
95	951921 00000	PIEZA DE ORMA DE GOMA	
96	068000 27600	PIEZA DISTANCIADORA	
97	945363 00000	TORNILLO HEXAGONAL INTERIOR	
98	949451 00000	ARANDELA	
102	968104 00000	PIEZA DE GOMA DISTANCIADORA	
103	029600 16300	BULÓN	
123	728003 99611	VÁLVULA REGULADORA DE PRESIÓN	
129	943131 00000	TOBERA	
133	951224 00000	TORNILLO DE CIERRE	

¹⁾ cantidad necesario / mantenimiento

DT 4.10 (1~) Versión - AC monofásica

Para posiciones que derivan del aparato standard véase apéndice (lado trasero del plano) 

OPCIONAL

Index	Pos.	No. De pedido	Descripción 
DT 4.16	15	020000 16300	ÉMBOLO
	16	016800 16300	ARANDELA TENSORA
	17	911009 00000	ANILLO DE TOLERANCIA STAR
	18	949203 00000	POLEA DENTADA
	19	945320 00000	TORNILLO HEXAGONAL INTERIOR
	21	000105 16300	CARCASA
	23	945321 00000	TORNILLO HEXAGONAL INTERIOR
	24	901347 00000	EMPUJADOR DE CARBÓN (7x)¹⁾
	28	000705 16300	TAPA LATERAL
	29	945372 00000	TORNILLO HEXAGONAL INTERIOR
	30	008901 16300	JUNTA
	61	004800 27400	TAPA DE FILTRO
	67	009000 16300	MUELLE DE PRESIÓN
69	952009 00000	CASQUILLO TENSOR	
72	909519 00000	CARTUCHO DE FILTRO (1x)¹⁾	
74	909542 00000	CARTUCHO DE FILTRO (1x)¹⁾	
76	945325 00000	TORNILLO HEXAGONAL INTERIOR	
77	948021 00000	ANILLO DE JUNTA	
78	913161 00000	JUNTA TÓRICA	
83	006800 27400	CAPERUZA DE APARATO	
84	060901 16300	TIRAS DE AMORTIGUACIÓN	
85	741310 50000	AMORTIGUADOR DE GOMA	
86	949402 00000	ARANDELA	
87	947001 00000	TUERCA HEXAGONAL	
88	006801 27400	CAPERUZA FRONTAL	
89	741310 40000	AMORTIGUADOR DE GOMA	
90	945318 00000	TORNILLO HEXAGONAL INTERIOR	
91	951922 00000	PIEZA DE ORMA DE GOMA	
94	015100 27400	PIE DE MOTOR	
95	951921 00000	PIEZA DE ORMA DE GOMA	
96	068000 27600	PIEZA DISTANCIADORA	
97	945363 00000	TORNILLO HEXAGONAL INTERIOR	
98	949451 00000	ARANDELA	
102	968104 00000	PIEZA DE GOMA DISTANCIADORA	
103	029600 16300	BULÓN	
123	728003 99611	VÁLVULA REGULADORA DE PRESIÓN	
129	943131 00000	TOBERA	
133	951224 00000	TORNILLO DE CIERRE	

¹⁾ cantidad necesario / mantenimiento

DT 4.16 (1~) Versión - AC monofásica
DT 4.16/05-51 (1~) Versión especial
(3~) Versión especial
DT 4.16K/0-06 (3~) Versión con refrigerador - sin filtro / AC trifásica

Para posiciones que derivan del aparato standard véase apéndice (lado trasero del plano) 

OPCIONAL

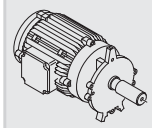

SERVICE ?

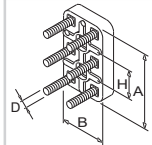
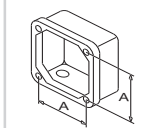
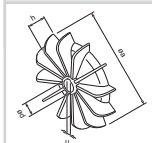

1~

C = ? μ F
U = ? V

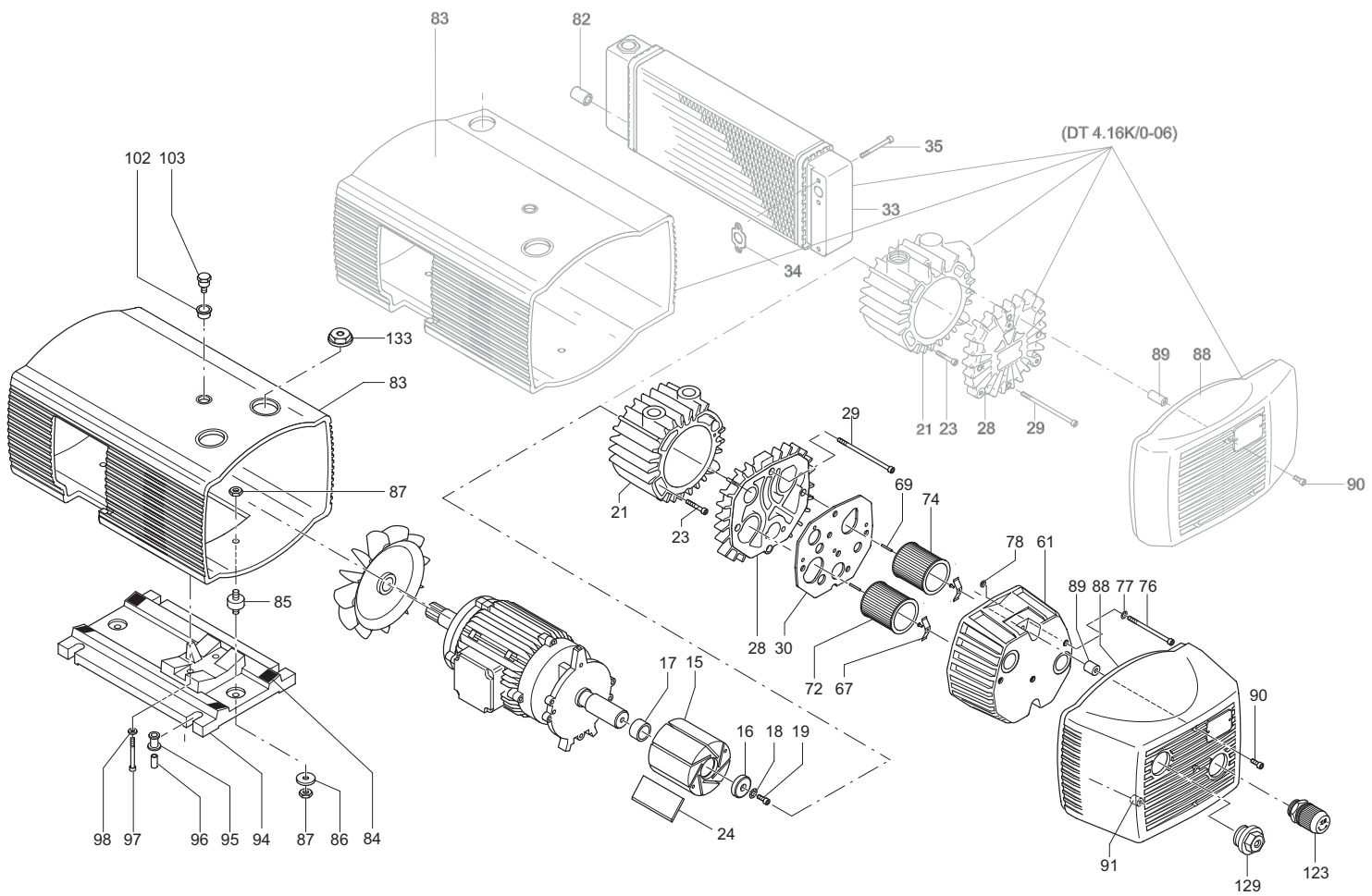
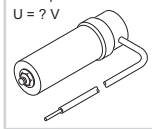

standard

DT 4.10 (3~)
DT 4.16 (3~)

optional
en option
opcionale
opcional

