

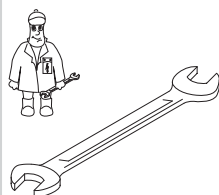

Gebr. Becker GmbH & Co.KG
Hölker Feld 29-31
D-42279 Wuppertal

Wartung
Maintenance
Entretien
Manutenzione
Mantenimiento



	Pos.	Menge * Quantity * Quantité * Quantità * Cantidad *	Bestell-Nr. Ident No. No. Identification No. Identificazione No. de pedido	Bezeichnung Description Designation Designazione Descripcion
VT 4.40/0-400	24	7	90135200000	Schieber, Rotor Vane, Palette, Silenciador
	72	1	909505 00000	Filterpatrone, Filter cartridge, Cartouche Filtrante, Cartuccia filtro, Cartucho de filtro

* erforderlich / necessary / nécessaire / necessaria / necesaria



Ersatzteilliste
Spare parts list
Liste de pièces de rechange
Listino pezzi di ricambio
Lista de piezas de recambio
Lista de peças sobresselentes
Reserveonderdelenlijst
Reservedelsliste
Reservdelslista

Reservedelsliste
Varaosaluettelo
Wykaz czêœci zamiennych
Seznam náhradních dílů
Tartalékalkatrész lista
Κατάλογος ανταλλακτικών
Перечень запасных частей
备用零件目录
スペアパーツリスト

VT 4.40/0-400



28 0100 00000 05/2004



VT 4.40/0-400

Index	Pos.	Bestell Nr.	Beschreibung 
	13	945315 0000	INNENSECHSKANTSCHRAUBE
	15	020000 16500	KOLBEN
	16	016800 16500	SPANNSCHEIBE
	17	911008 00000	STAR-TOLERANZRING
	18	949203 00000	ZAHNSCHEIBE
	19	945320 00000	INNENSECHSKANTSCHRAUBE
	21	000102 16500	GEHÄUSE
	22	951806 00000	SPANNHÜLSE
	23	945322 00000	INNENSECHSKANTSCHRAUBE
	24	901352 00000	SCHIEBER, KOHLE (7x) ¹⁾
	25	952009 00000	SPANNHÜLSE
	28	000710 16500	SEITENDECKEL
	29	945374 00000	INNENSECHSKANTSCHRAUBE
	30	008900 16500	DICHTUNG
	46	902300 26200	VENTILATOR MIT NABE
	48	947713 00000	PASSFEDER
	49	949454 00000	U-SCHEIBE
	50	901804 00000	WELLENENDSCHRAUBE TUFLOK
	61	004803 27600	FILTERDECKEL
	67	009000 16300	ANPRESSFEDER
	72	909505 00000	FILTERPATRONE (1x) ¹⁾
	76	945373 00000	INNENSECHSKANTSCHRAUBE
	77	948021 00000	DICHTRING
	78	913161 00000	O-RING
	83	006808 27600	GERÄTEHAUBE
	85	951920 00000	GUMMIFORMTEIL
	88	006802 27600	GERÄTEHAUBE
	89	741365 00000	GUMMIPUFFER
	90	945318 00000	INNENSECHSKANTSCHRAUBE
	91	951922 00000	GUMMIFORMTEIL
	92	964109 00000	KANTENSCHUTZ
	94	015100 27600	FUSS
	95	951921 00000	GUMMIFORMTEIL
	96	068000 27600	DISTANZSTÜCK
	97	945328 00000	INNENSECHSKANTSCHRAUBE
	98	949451 00000	UNTERLEGSCHNEIBE
	101	833903 99597	VENTILTELLER
	102	951906 00000	KABELTÜLLE
	103	068002 16500	DISTANZROHR
	104	548800 16300	RINGSCHRAUBE
	106	946304 00000	SCHRAUBE

VT 4.40/0-400

Index	Pos.	Bestell Nr.	Beschreibung 
	107	769310 26000	STECKER
	108	761300 27600	DICHTUNG
	109	961301 19600	DICHTUNG
	110	003600 29100	ZWISCHENFLANSCH
	111	951914 00000	GUMMITÜLLE
	112	951913 00000	GUMMITÜLLE
	113	742003 90000	KABEL
	114	742003 80000	KABEL
	115	945215 00000	SECHSKANTSCHRAUBE
	116	947104 00000	SECHSKANTMUTTER
	117	951703 00000	FEDERSCHNEIBE
	118	949402 00000	UNTERLEGSCHNEIBE
	124	736001 99613	VAKUUMREGULIERVENTIL
	127	727502 06000	ABBLASEVENTIL
	130	951225 00000	VERSCHLUSSSCHRAUBE
	204	769302 40840	FREQUENZUMRICHTER

¹⁾ erforderliche Bestellmenge / WartungZeichnung - siehe Anhang 

VT 4.40/0-400

Index	Pos.	Ident No.	Description 
	13	945315 00000	SOCKET HEAD SCREW
	15	020000 16500	ROTOR
	16	016800 16500	CLAMPING DISC
	17	911008 00000	STAR-TOLERANCE-RING
	18	949203 00000	TOOTHED SPRING WASHER
	19	945320 00000	SOCKET HEAD SCREW
	21	000102 16500	PUMP BODY
	22	951806 00000	LOCATING PEG
	23	945322 00000	SOCKET HEAD SCREW
	24	901352 00000	CARBON VANES (7x) ¹⁾
	25	952009 00000	LOCATING PEG
	28	000710 16500	LID
	29	945374 00000	SOCKET HEAD SCREW
	30	008900 16500	GASKET
	46	902300 26200	FAN
	48	947713 00000	KEY
	49	949454 00000	WASHER
	50	901804 00000	SHAFT END BOLD
	61	004803 27600	FILTER COVER
	67	009000 16300	LEAF SPRING
	72	909505 00000	FILTER CARTRIDGE (1x) ¹⁾
	76	945373 00000	SOCKET HEAD SCREW
	77	948021 00000	SEALING RING
	78	913161 00000	O-RING
	83	006808 27600	PROTECTING HOOD
	85	951920 00000	RUBBER ELEMENT
	88	006802 27600	PROTECTING HOOD
	89	741365 00000	RUBBER BUFFER
	90	945318 00000	SOCKET HEAD SCREW
	91	951922 00000	RUBBER ELEMENT
	92	964109 00000	EDGE PROTECTION
	94	015100 27600	FOOT
	95	951921 00000	RUBBER ELEMENT
	96	068000 27600	SPACING COLLAR
	97	945328 00000	SOCKET HEAD SCREW
	98	949451 00000	WASHER
	101	833903 99597	VALVE DISC
	102	951906 00000	RUBBER BUSHING
	103	068002 16500	SPACER TUBE
	104	548800 16300	RING SCREW
	106	946304 00000	SCREW

VT 4.40/0-400

Index	Pos.	Ident No.	Description 
	107	769310 26000	PLUG
	108	761300 27600	GASKET
	109	961301 19600	GASKET
	110	003600 29100	FLANGES
	111	951914 00000	RUBBER BUSHING
	112	951913 00000	RUBBER BUSHING
	113	742003 90000	CABLE
	114	742003 80000	CABLE
	115	945215 00000	HEX-HEAD SCREW
	116	947104 00000	HEX.NUT
	117	951703 00000	SPRING DISC
	118	949402 00000	WASHER
	124	736001 99613	VACUUM REGULATING VALVE
	127	727502 06000	BLOW-OFF VALVE
	130	951225 00000	LOCKING SCREW
	204	769302 40840	INVERTER

¹⁾ necessary order quantity / maintenance

drawing - see appendix 

VT 4.40/0-400

Index	Pos.	No. Identification	Designation
	13	945315 00000	VIS HEXAGONALE INTERNE
	15	020000 16500	PISTON
	16	016800 16500	DISQUE DE SERRAGE
	17	911008 00000	BAGUE STAR
	18	949203 00000	DENT DISQUE
	19	945320 00000	VIS HEXAGONALE INTERNE
	21	000102 16500	CORP DE POMPE
	22	951806 00000	DOUILLE DE ETRAGE
	23	945322 00000	VIS HEXAGONALE INTERNE
	24	901352 00000	PALETTE DE CHARBON (7x) ¹⁾
	25	952009 00000	DOVILLE DE ETRAGE
	28	000710 16500	COUVERCLE
	29	945374 00000	VIS HEXAGONALE INTERNE
	30	008900 16500	JOINT
	46	902300 26200	VENTILATEUR
	48	947713 00000	CLAVETTE
	49	949454 00000	RONDELLE
	50	901804 00000	VIS BOUT D'ARBRE
	61	004803 27600	COUVERCLE DU FILTRE
	67	009000 16300	RESSORT-JAME
	72	909505 00000	CARTOUCHE FILTRANTE (1x) ¹⁾
	76	945373 00000	VIS HEXAGONALE INTERNE
	77	948021 00000	JOINT
	78	913161 00000	ANNEAU-O
	83	006808 27600	CARTER PROTECTEUR
	85	951920 00000	ELEMENT EN CAOUTCHOUC
	88	006802 27600	CARTER PROTECTEUR
	89	741365 00000	AMORTISSEUR EN CAOUTCHOUC
	90	945318 00000	VIS HEXAGONALE INTERNE
	91	951922 00000	ELEMENT EN CAOUTCHOUC
	92	964109 00000	PROTECTION D'ARETE
	94	015100 27600	PIED
	95	951921 00000	ELEMENT EN CAOUTCHOUC
	96	068000 27600	DONILLE D'ECARMENT
	97	945328 00000	VIS HEXAGONALE INTERNE
	98	949451 00000	RONDELLE
	101	833903 99597	PLATEAU DE SOUPAPE
	102	951906 00000	PROTECTION EN CAOUTCHOUC
	103	068002 16500	TUBE D'ECARTEMENT
	104	548800 16300	PITON
	106	946304 00000	VIS

VT 4.40/0-400

Index	Pos.	No. Identification	Designation
	107	769310 26000	PRISE
	108	761300 27600	JOINT
	109	961301 19600	JOINT
	110	003600 29100	BRIDES
	111	951914 00000	PROTECTION EN CAOUTCHOUC
	112	951913 00000	PROTECTION EN CAOUTCHOUC
	113	742003 90000	CABLE
	114	742003 80000	CABLE
	115	945215 00000	VIS HEXAGONALE
	116	947104 00000	ECROU A 6PANS
	117	951703 00000	DISQUE DE RESSORT
	118	949402 00000	RONDELLE
	124	736001 99613	SOUPAPE REGLAGE VIDE
	127	727502 06000	SILENCIEUX
	130	951225 00000	BOUCHON
	204	769302 40840	CONVERTISSEUR DE FREQUENCE

¹⁾ quantité nécessaire / entretien

plan - voir annexe

VT 4.40/0-400

Index	Pos.	No. Identificazione	Designazione
	13	945315 00000	VITE ESAGONALE INTERNA
	15	020000 16500	ROTORE
	16	016800 16500	DISCO DI FISSAGGIO
	17	911008 00000	STAR-ANNELLO TOLLERANZA
	18	949203 00000	DISCO A DENTE
	19	945320 00000	VITE ESAGONALE INTERNA
	21	000102 16500	CARCASSA
	22	951806 00000	SPINE DI RISCONTRO
	23	945322 00000	VITE ESAGONALE INTERNA
	24	901352 00000	PALETTE DI CHARBONE (7x)¹⁾
	25	952009 00000	SPINE DI RISCONTRO
	28	000710 16500	COPERCHIO
	29	945374 00000	VITE ESAGONALE INTERNA
	30	008900 16500	GUARNIZIONE
	46	902300 26200	VENTILATORE
	48	947713 00000	CHIAVETTA
	49	949454 00000	RONDELLA
	50	901804 00000	VITE DI CHIUSURA ALBERO
	61	004803 27600	COPERCHIO FILTRO
	67	009000 16300	MOLLA
	72	909505 00000	CARTUCCIA FILTRO (1x)¹⁾
	76	945373 00000	VITE ESAGONALE INTERNA
	77	948021 00000	ANELLO GUARNIZIONE
	78	913161 00000	ANELLO-O
	83	006808 27600	CARTER DI PROTEZIONE
	85	951920 00000	ELEMENTO IN GOMMA
	88	006802 27600	CARTER DI PROTEZIONE
	89	741365 00000	AMMORTIZZATORE IN GOMMA
	90	945318 00000	VITE ESAGONALE INTERNA
	91	951922 00000	ELEMENTO IN GOMMA
	92	964109 00000	LISTELLO DI PROTEZIONE
	94	015100 27600	PIEDE
	95	951921 00000	ELEMENTO IN GOMMA
	96	068000 27600	BOCCOLA DISTANZIATRICE
	97	945328 00000	VITE ESAGONALE INTERNA
	98	949451 00000	RONDELLA
	101	833903 99597	PIATELLO DELLA VALVOLA
	102	951906 00000	PROTEZIONE IN GOMMA
	103	068002 16500	TUBO DISTANZA
	104	548800 16300	GANCIO
	106	946304 00000	VITE

VT 4.40/0-400

Index	Pos.	No. Identificazione	Designazione
	107	769310 26000	SPINA
	108	761300 27600	GUARNIZIONE
	109	961301 19600	GUARNIZIONE
	110	003600 29100	FLANGE
	111	951914 00000	PROTEZIONE IN GOMMA
	112	951913 00000	PROTEZIONE IN GOMMA
	113	742003 90000	CAVO
	114	742003 80000	CAVO
	115	945215 00000	VITE ESAGONALE
	116	947104 00000	DADO ESAGONALE
	117	951703 00000	DISCO A MOLLA
	118	949402 00000	RONDELLA
	124	736001 99613	VALVOLA REGOLAZIONE VUOTO
	127	727502 06000	SILENZIATORE
	130	951225 00000	VITE DI CHIUSURA
	204	769302 40840	INVERTER

¹⁾ quantità di ordinazione necessari / manutenzione

disegno - vedere allegato

VT 4.40/0-400

Index	Pos.	No. De pedido	Descripción 
	13	945315 00000	TORNILLO HEXAGONAL INTERIOR
	15	020000 16500	ÉMBOLO
	16	016800 16500	ARANDELA TENSORA
	17	911008 00000	ANILLO DE TOLERANCIA STAR
	18	949203 00000	POLEA DENTADA
	19	945320 00000	TORNILLO HEXAGONAL INTERIOR
	21	000102 16500	CARCASA
	22	951806 00000	CASQUILLO TENSOR
	23	945322 00000	TORNILLO HEXAGONAL INTERIOR
	24	901352 00000	EMPUJADOR DE CARBÓN (7x) ¹⁾
	25	952009 00000	CASQUILLO TENSOR
	28	000710 16500	TAPA LATERAL
	29	945374 00000	TORNILLO HEXAGONAL INTERIOR
	30	008900 16500	JUNTA
	46	902300 26200	ALETA DE VENTILADOR
	48	947713 00000	LENGÜETA DE AJUSTE
	49	949454 00000	ARANDELA
	50	901804 00000	TORNILLO TERMINAL DE ÁRBOL
	61	004803 27600	TAPA DE FILTRO
	67	009000 16300	MUELLE DE PRESIÓN
	72	909505 00000	CARTUCHO DE FILTRO (1x) ¹⁾
	76	945373 00000	TORNILLO HEXAGONAL INTERIOR
	77	948021 00000	ANILLO DE JUNTA
	78	913161 00000	JUNTA TÓRICA
	83	006808 27600	SOMBRERETE DE APARATO
	85	951920 00000	PIEZA DE ORMA DE GOMA
	88	006802 27600	CAPERUZA DE APARATO
	89	741365 00000	AMORTIGUADOR DE GOMA
	90	945318 00000	TORNILLO HEXAGONAL INTERIOR
	91	951922 00000	PIEZA DE ORMA DE GOMA
	92	964109 00000	PROTECCIÓN DE CANTOS
	94	015100 27600	PIE
	95	951921 00000	PIEZA DE ORMA DE GOMA
	96	068000 27600	PIEZA DISTANCIADORA
	97	945328 00000	TORNILLO HEXAGONAL INTERIOR
	98	949451 00000	ARANDELA
	101	833903 99597	PLATILLO DE VÁLVULA
	102	951906 00000	BOQUILLA DE CABLE
	103	068002 16500	TUBO DISTANCIADOR
	104	548800 16300	TORNILLO DE CÁNCAMO
	106	946304 00000	TORNILLO DE SUJECIÓN

VT 4.40/0-400

Index	Pos.	No. De pedido	Descripción 
	107	769310 26000	CONECTOR
	108	761300 27600	JUNTA
	109	961301 19600	JUNTA
	110	003600 29100	BRIDA INTERMEDIA
	111	951914 00000	BOQUILLA DE CABLE
	112	951913 00000	BOQUILLA DE CABLE
	113	742003 90000	CABLE
	114	742003 80000	CABLE
	115	945215 00000	TORNILLO DE CABEZA HEXAGONAL
	116	947104 00000	TUERCA HEXAGONAL
	117	951703 00000	ARANDELA ELÁSTICA
	118	949402 00000	ARANDELA
	124	736001 99613	VÁLVULA REGULADORA DE VACÍO
	127	727502 06000	VÁLVULA DE BARRIDO
	130	951225 00000	TORNILLO DE CIERRE
	204	769302 40840	CONVERTIDOR DE FRECUENCIA

¹⁾ cantidad necesario / mantenimiento

plano - véase apéndice 

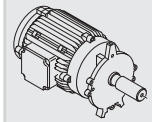

SERVICE ?

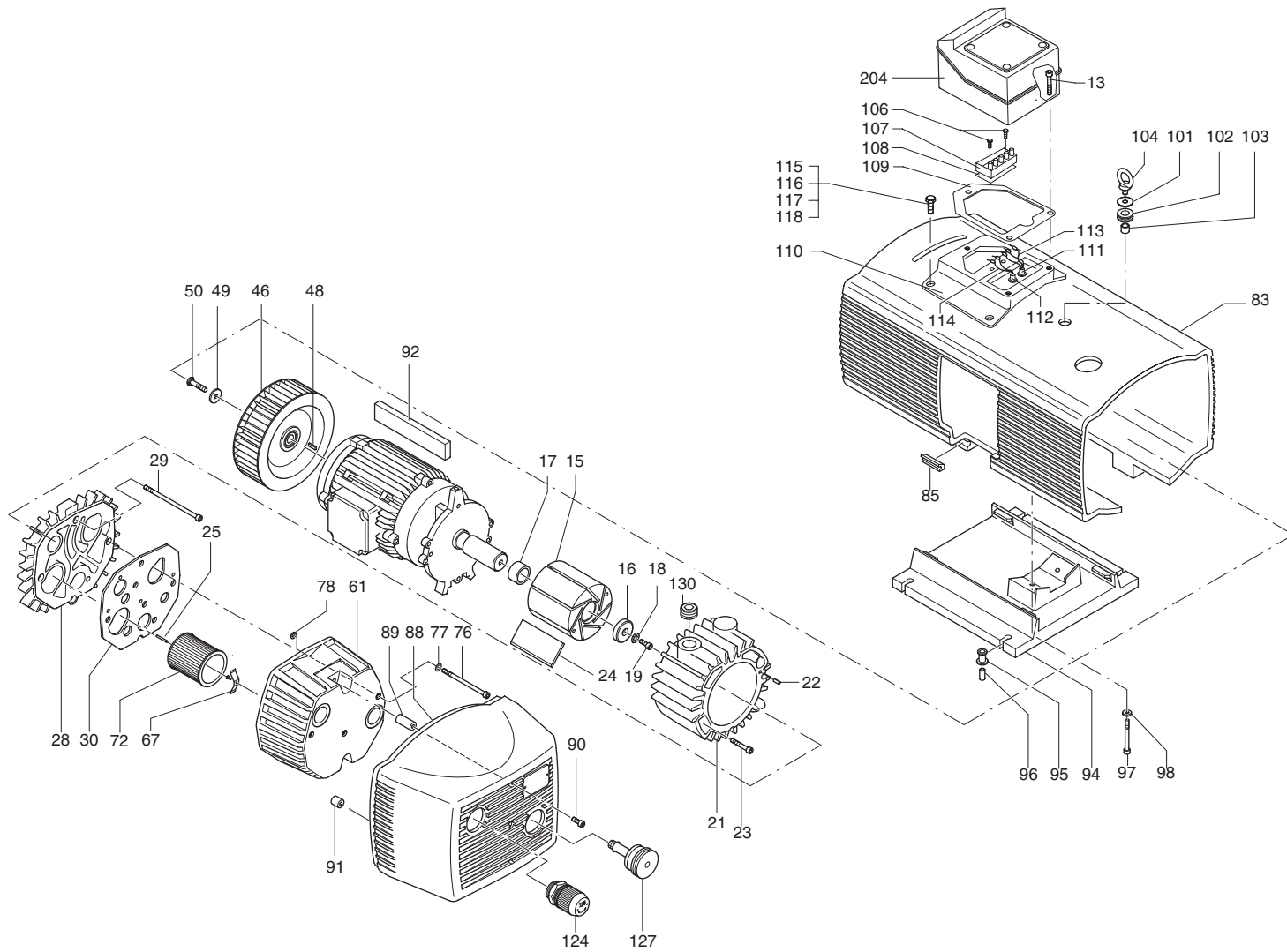
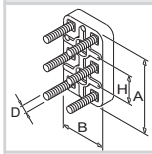
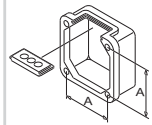
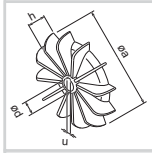

standard

VT 4.40/0-400