

**Drehschieber-Druck-Vakuumpumpen, 2 unabhängige Verdichtungsräume, trockenlaufend, luftgekühlt**

**Rotary vane pressure/vacuum pumps, 2 independent compression chambers, oil-free, air-cooled**

**Pompes combinées à palettes, 2 chambres de compression indépendantes, fonctionnant à sec, refroidies par air**

**Pompe combinata a palette, 2 camere di compressione indipendenti, funzionanti a secco, raffreddate ad aria**

**Bombas combinadas de paletas, 2 compartimentos de compresión independientes, sin aceite, refrigeradas por aire**

**E PV40/PV40i**

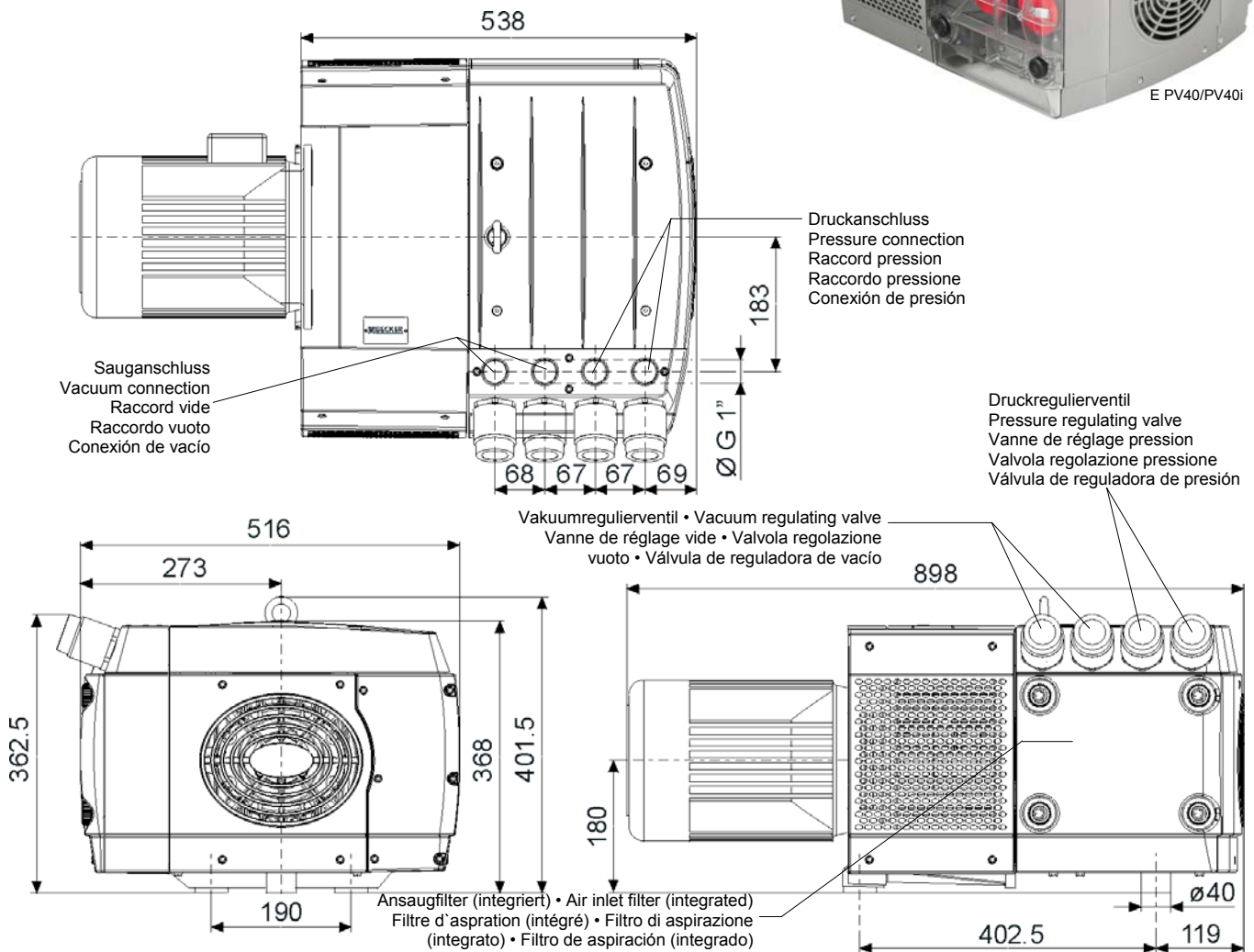

Technische Daten		Technical data		Caractéristiques technique		Dati tecnici		Datos técnicos	
E PV40/PV40i	PV40		bar (max. rel. <sup>1)</sup>	PV40		kW	dB(A) <sup>2)</sup>		kg
	m <sup>3</sup> /h (max.)	60 Hz		m <sup>3</sup> /h (max.)	60 Hz		50 Hz	60 Hz	
	40	48	±0,5	40	48	3,0   3,5	74	76	147
							▶ M1		

	M1	50 Hz ▶ 3,0 kW • 190-254/330-440 V Δ/Y • 14,2-19,9/8,2-10,4 A • 950-975 min <sup>-1</sup>	60 Hz ▶ 3,6 kW • 190-288/330-500 V Δ/Y • 16,8-16,0/9,7-9,30 A • 1120-1170 min <sup>-1</sup>		B5 (Ø 300) • IP 55
--	----	---	---	--	--------------------

1) ▶ bar relativ • bar relative • bar relatif • bar relativo • bar relativo  
 2) ▶ bei mittlerer Belastung, beide Seiten abgeleitet • at medium load, both sides derived • à régime moyen, les deux côtés dérivés • a medio regime, entrambi i lati derivati • en la carga media, ambos lados derivados ▶ DIN EN ISO 2151 + DIN EN ISO 3744 (K<sub>PA</sub> = 3 dB(A))  
 Maßangaben in mm • Measures in mm • Mesures en mm • Misure in mm • Medidas en mm  
 Änderungen vorbehalten • Right of modification reserved • Sous réserve des modifications • Sotto riserva di modificazioni • Derecho a modificaciones reservado

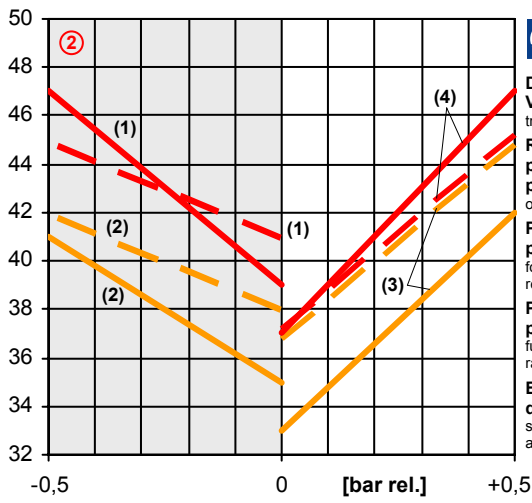
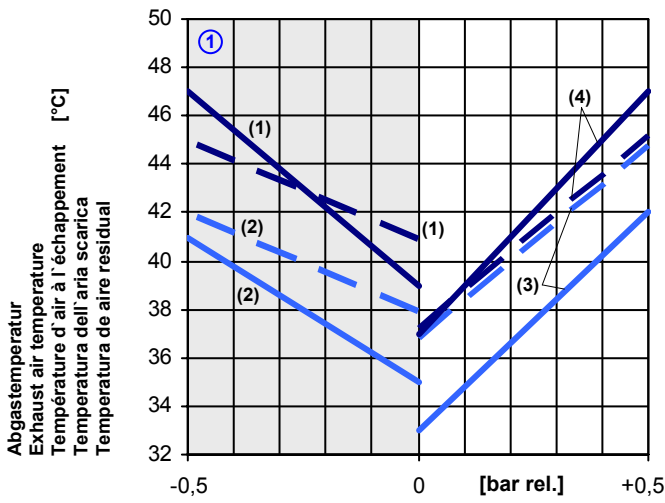

**Drehschieber-Druck-Vakuumpumpen,**  
trockenlaufend, luftgekühlt  
**Rotary vane pressure/vacuum pumps,**  
oil-free, air-cooled  
**Pompes combinées à palettes,**  
fonctionnant à sec, refroidies par air  
**Pompe combinata a palette,**  
funzionanti a secco, raffreddate ad ari  
**Bombas combinadas de paletas,**  
sin aceite, refrigeradas por aire

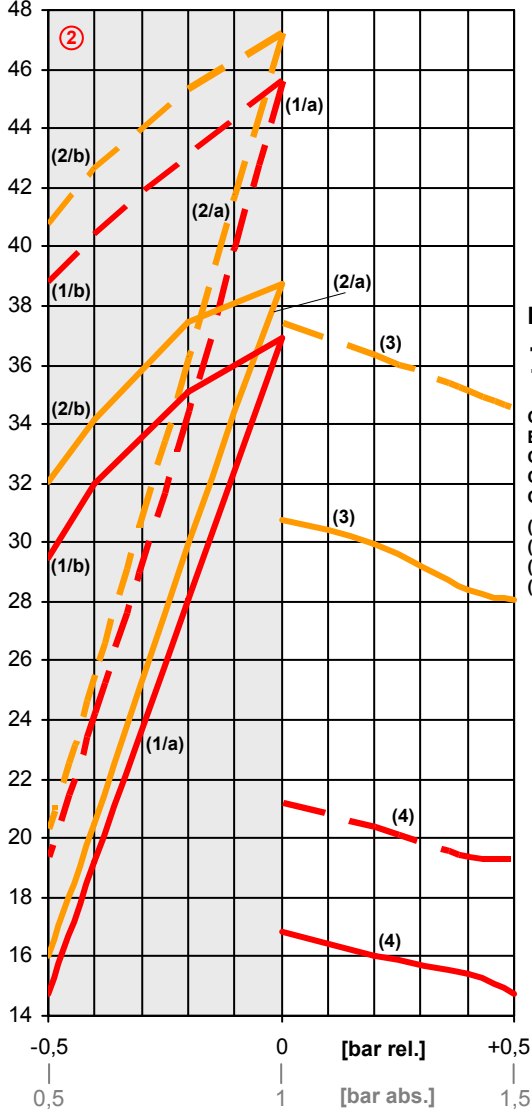
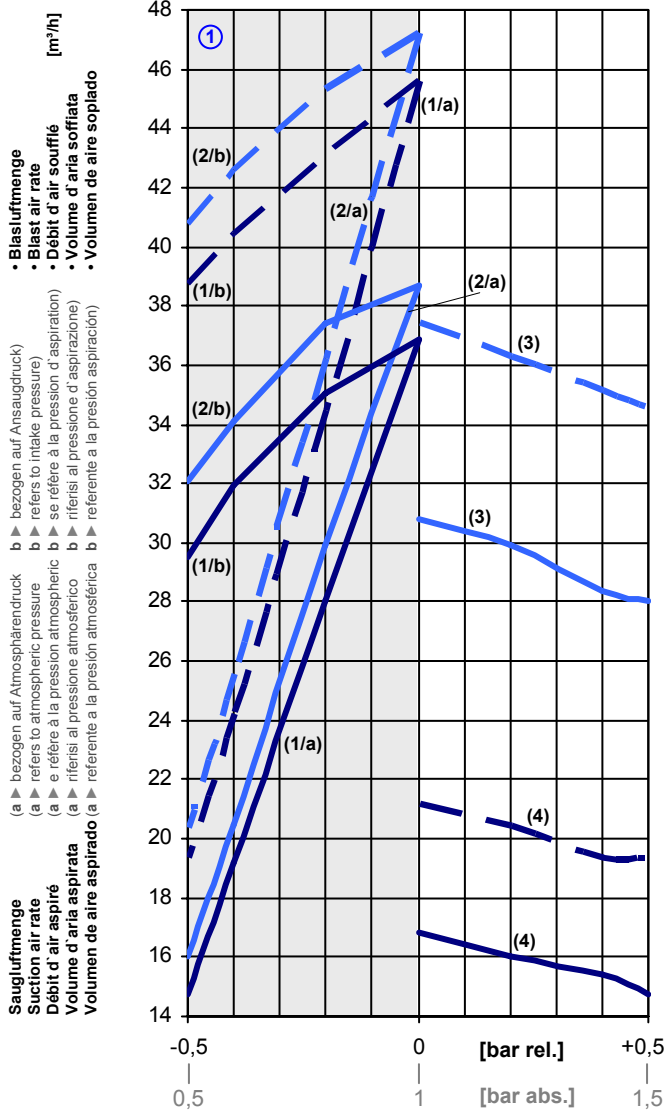

① ②  
**E PV40/PV40i**  
— 50 Hz  
- - - 60 Hz

**Gegendruck**  
Back pressure  
Contre-pression  
Contropressione  
Contrapresión

(1) +0,5 bar  
(2) +0,2 bar  
(3) -0,2 bar  
(4) -0,5 bar

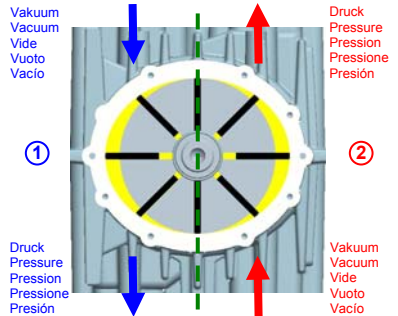
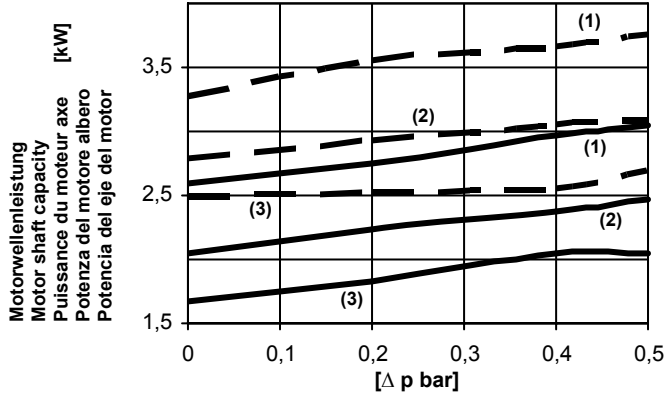

bar abs. ▶ bar absolute • bar absolu • bar assoluto • bar absoluto • bar absoluto  
bar rel. ▶ bar relativ • bar relatif • bar relatif • bar relativo • bar relativo  
Bezugsdaten (Atmosphäre) • Référence (atmosphère) • Referência (atmosfera) ▶ 1013 mbar, 20°C  
Mögliche Abweichung • Allowable tolerance • Tolleranza (atmosfera) ▶ ±5 %  
possibile • Variazione possibile • Desvío posible ▶ ±5 %  
Änderungen vorbehalten • Right of modification reserved • Sous réserve des modifications • Sotto riserva di modificazioni • Derecho a modificaciones reservado